



CASTROVIEJO
24-0628-20
7 cm CM



PITANGUY
1064-30
16 cm

1037-15
15 cm

1037-20
20 cm

1037-30
30 cm



IRIS



9 cm
1101-09



10.5 cm
1101-10
1101-110
1101-111



11.5 cm
1101-11
34-0007-11
34-0005-11
34-0009-11



12.5 cm
1101-12

standard
supercut
TC
SuperCut T/C



GREENBERG PAR 11,5 cm



T/C
supercut plus
1160-122
1161-122



IRIS



9 cm
1102-09



10,5 cm
1102-10
1102-110
1102-111



11,5 cm
1102-11
34-0013-11
34-0011-11
34-0015-11



12,5 cm
1102-12
1102-112

standard
supercut
TC
SuperCut T/C

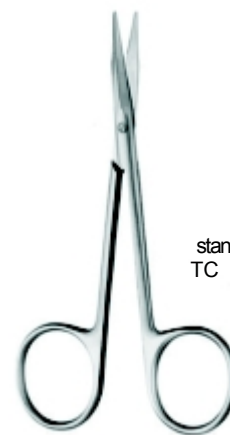

SIEGERT 11,5 cm

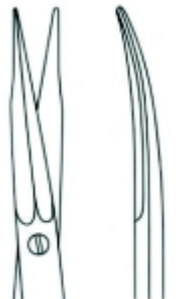

standard
TC
1158-131
1158-61
1158-132
1158-62

STEVENS 10 cm



SuperCut

Остроконечные



Прямые

34-0019-10



Изогнутые

34-0031-10

Тупоконечные



Прямые

34-0021-10



Изогнутые

34-0033-10



STEVENS 13 cm



standard
supercut

1110-15
34-0055-13

STEVENS



STEVENS 11,5 cm

standard
SuperCut

1110-12
34-0037-11



1110-13
34-0049-11



LEXER BABY 10 cm

standard
TC

1111-10
1113-60



1112-10
1113-61



KNAPP 12,5 cm

standard
supercut
TC

1111-12
1111-112
1112-62



1112-12
1112-112
1113-62



KNAPP 10 cm

standard

1111-70



1112-70



KNAPP

standard
supercut

12 cm
1111-32
1111-132



12 cm
1112-32
1112-132



12 cm
1111-52



12 cm
1112-52

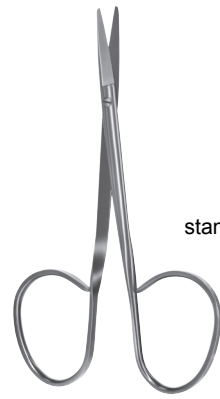

standard

9.5 cm
1112-90



MAYO STILLE

standard
supercut
TC
supercut plus



15 cm
1130-15
34-0229-15
7-0256-15
34-0231-15



17 cm
1130-17
34-0235-17
7-0256-17
34-0237-17



LA GRANDE 11 cm

Standard
T/C

7-1114-11
1118-02
Supercut T/C 1118-03



MAYO

standard
supercut
TC
supercut plus

14 cm
1124-14
34-0181-14
34-0179-14
34-0183-14



14 cm
1125-14
34-0205-14
34-0203-14
34-0207-14



17 cm
1124-17
34-0193-17
34-0191-17
34-0195-17



17 cm
1125-17
34-0217-17
34-0215-17
34-0219-17





supercut **1132-187**
 TC **1132-97**
 supercut plus **1132-197**

MAYO LEXER 16,5 cm



standard	7-0199-16	7-2000-16
supercut	7-0023-16	7-0024-16
TC	7-0203-16	7-0204-16
supercut plus	1134-196	1135-196

LEXER 16 cm

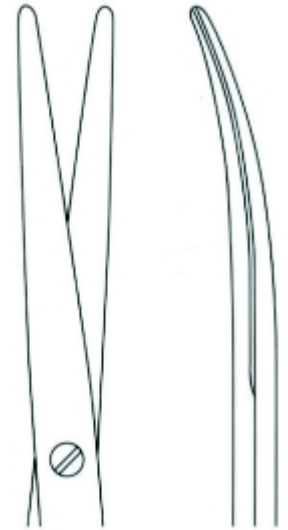

standard	07-0263-11	07-0264-11
supercut	07-0029-11	07-0030-11
TC	1136-61	1137-61
supercut plus	1136-161	1137-161

BABY METZENBAUM 11,5 cm

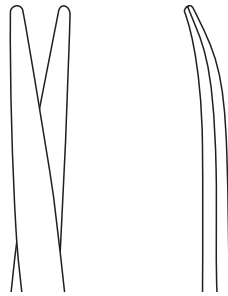

MINI METZENBAUM 9 cm
 SuperCut

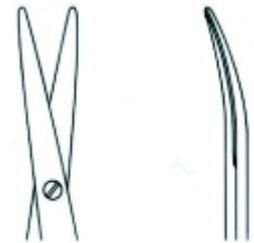

1136-109 **1137-109**



standard	15 cm	18 cm	20 cm
supercut	1136-14	1138-18	1138-20
TC	1136-114	1138-118	1138-120
supercut plus	1136-64	1138-68	1138-70
	1136-164	1138-168	1138-170

METZENBAUM

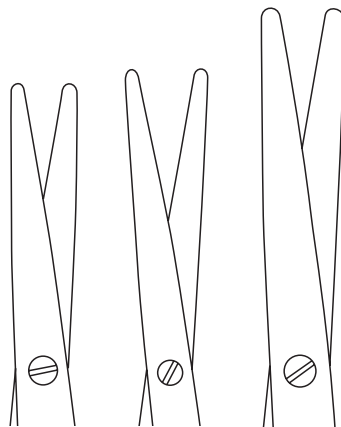

KAYE 11,5 cm
 SuperCut



1181-132



METZENBAUM

standard
supercut
TC
supercut plus

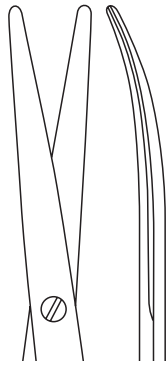

14 cm / 5½"
1137-14
1137-114
1137-64
1137-164

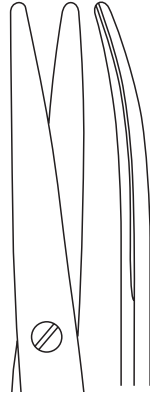

15 cm / 6"
1137-15
1137-115
1139-68
1139-168



18 cm / 7 1/8"
1139-18
1139-118
1139-70
1139-170



20 cm / 8"
1139-20
1139-120



NELSON METZENBAUM

standard
supercut
TC
supercut plus

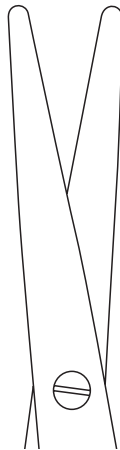

23 cm
1140-23
1140-123
1140-73
1140-173



1141-23
1141-123
1141-73
1141-173



26 cm
1140-26
1140-126
1141-26
1141-126
1141-76
1141-176

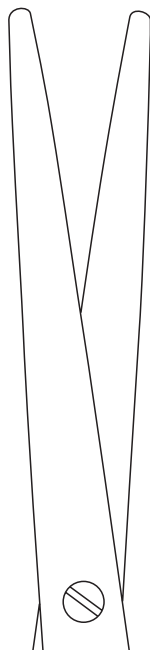

1140-30
1140-130

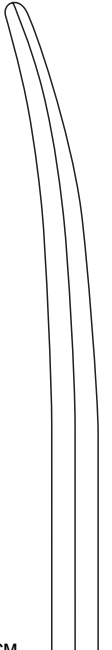

30 cm
1141-30
1141-130
1141-80
1141-180

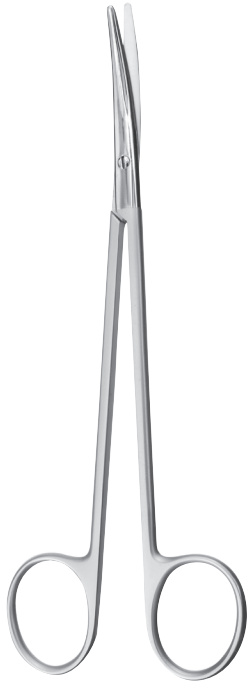

14 cm



18 cm



20 cm



23 cm

METZENBAUM-Fine	standard	1142-14	1143-14	1144-18	1145-18	1144-20	1145-20	1144-23	1145-23
	supercut	1142-114	1143-64	07-0041-18	07-0042-18	1144-120	1145-120	1144-123	1145-123
	TC	1142-64		1144-68	07-0343-18	1144-70	1145-70	1144-73	1145-73
	supercut plus	1142-164	1143-164	1144-168	34-0171-18	1144-170	1145-170	1144-173	1145-173



GORNEY-FREEMAN

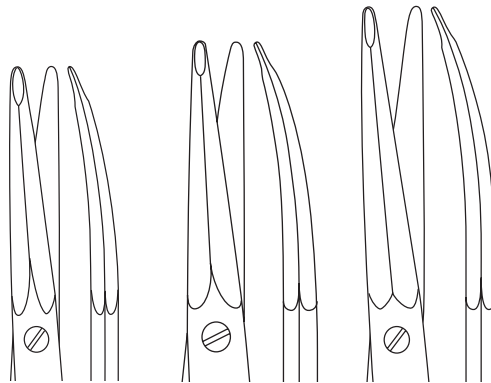

17 cm

19 cm - 7½"

23 cm - 9"

SuperCut	34-0357-17	1180-119	1180-123
TC	34-0355-17	1180-39	1180-43
SuperCut T/C	34-0359-17	1180-51	1180-53

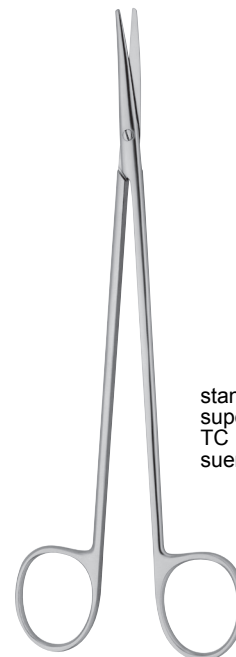

TOENNIS ADSON

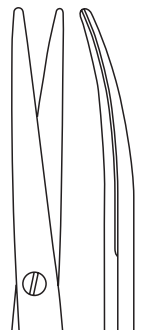

18 cm / 7 1/8"
1150-18
1150-118
1150-68
1150-168

standard
 supercut
 TC
 suercut plus

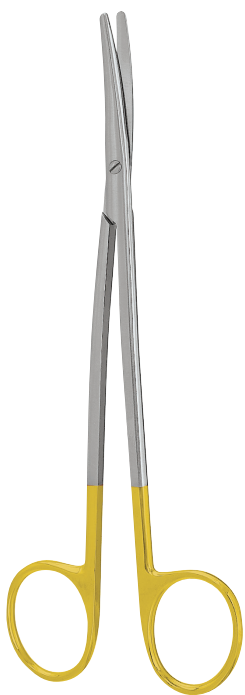

METZENBAUM S



supercut
TC
SuperCut T/C



18 cm	20 cm	23 cm
1146-168	1146-170	1146-173
1146-78	1146-80	1146-83
1146-178	1146-180	1146-183



BRUSER KELLY 16 cm
SuperCut



1148-116



1149-116



METZENBAUM FREEMAN

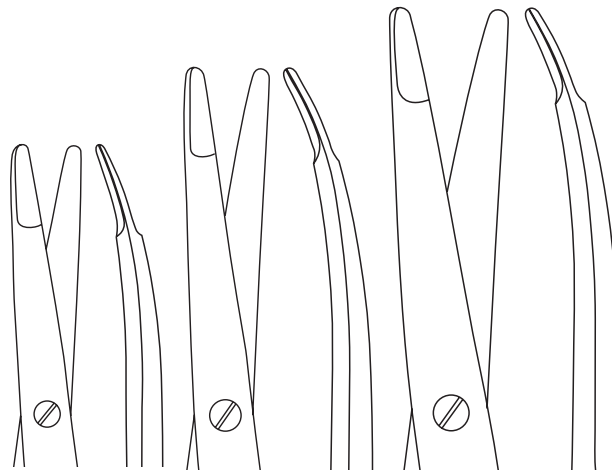

	18 cm	20 cm	23 cm
<i>SuperCut</i>	34-0343-18	34-0349-20	34-0353-23
<i>T/C</i>	34-0341-18	34-0347-20	34-0355-23
<i>SuperCut T/C</i>	34-0345-18	34-0351-20	34-0357-23

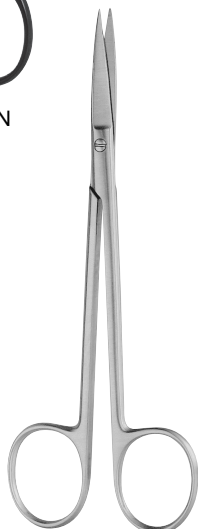

JOSEPH



standard supercut	15cm / 6" 1165-14	15cm / 6" 1166-14
	1165-114	1166-114

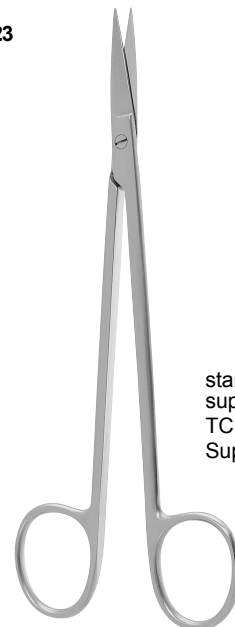

KELLY



standard	16 cm	16 cm
supercut	1146-16	1147-16
TC	1146-66	1147-66
SuperCut T/C	1146-166	1147-166





PECK JOSEPH 14 cm
SuperCut T/C

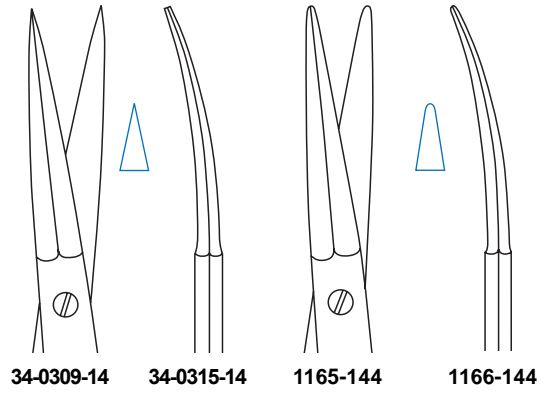

34-0309-14 34-0315-14 1165-144 1166-144



RAGNELL (KILNER)

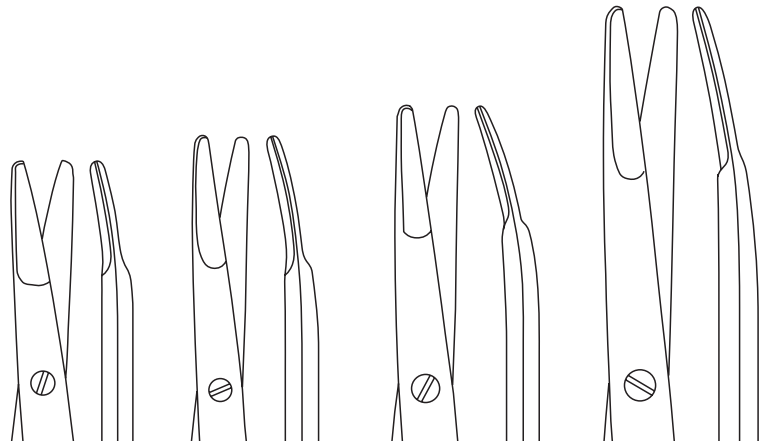

	13 cm	15 cm	18 cm	20 cm
standard	1159-13	1159-15	1159-18	1159-20
supercut	34-0289-13	34-0295-15	34-0301-18	
TC	34-0287-13	34-0293-15	34-0299-18	
SuperCut T/C	34-0291-13	34-0297-15	34-0302-18	



Sullivan

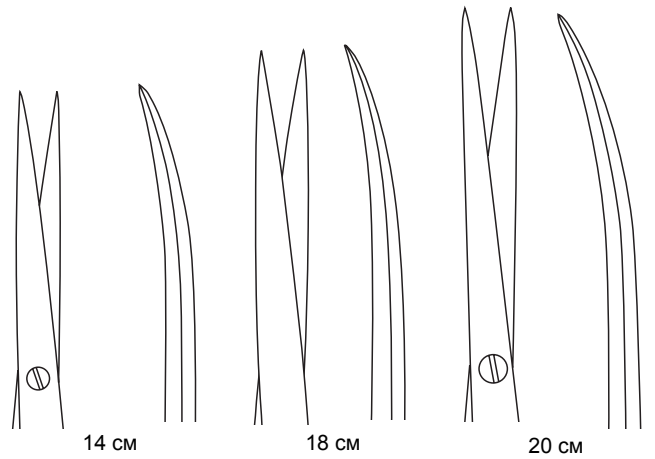

	14 cm	18 cm	20 cm		
standard	1167-14	1168-14	1167-18	1168-18	1167-20
supercut	1167-114	1168-114		1168-118	1168-20
TC	1167-64	1168-64			
supercut plus	1167-164	1168-164			



FANOUS



supercut 16.5 cm
34-0319-16



16.5 cm
34-0331-16



20.5 cm
34-0325-20



20,5 cm
34-0337-20



GORNEY

Flat tips

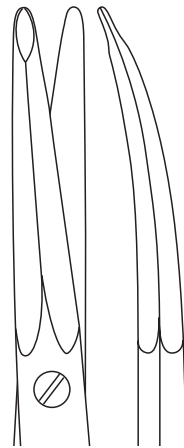

GORNEY

17cm
SuperCut 34-0363-17
T/C 34-0361-17
SuperCut T/C 34-0365-17

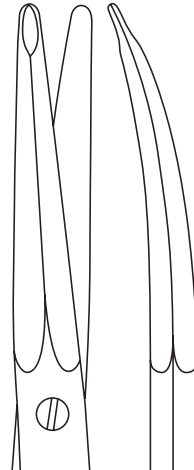

19 cm
34-0363-19
34-0361-19
34-0365-19

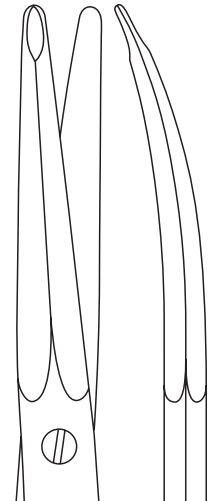

23 cm
34-0363-23
34-0361-23
34-0365-23



19 cm
supercut **1181-119**
TC **1181-39**
KAYE

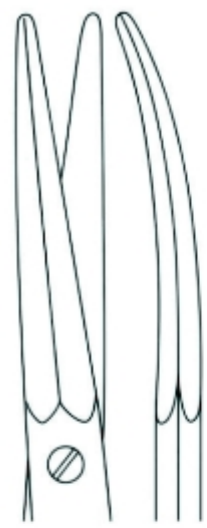

23 cm / 9"
1181-123
1181-43



SOLZ

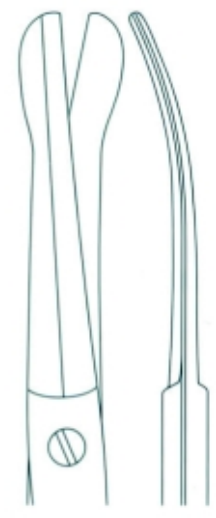

20 cm
supercut T/C **1183-230**



DEAN



17 cm / 6 3/4"
standard **1225-17**
supercut **1225-117**

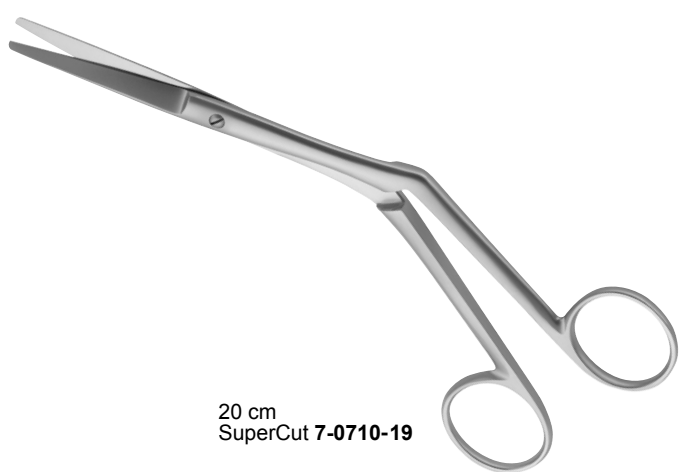

20 cm
SuperCut **7-0710-19**

HEYMANN



HEYMANN



standard **1217-17**
supercut **7-0129-17**



18 cm / 7 1/8"
7-0708-18
7-0129-18



20 cm / 8"
1217-20
7-0129-20



standard
supercut
supercut plus

FOMON



13 cm
7-0718-13
7-0139-13
1250-163



supercut

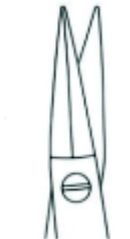

14 cm / 5½"
1250-14

WALTER



standard



12.5 cm / 5"
1251-43

FOMON

Ножницы Noues 11 см
7-0763-01

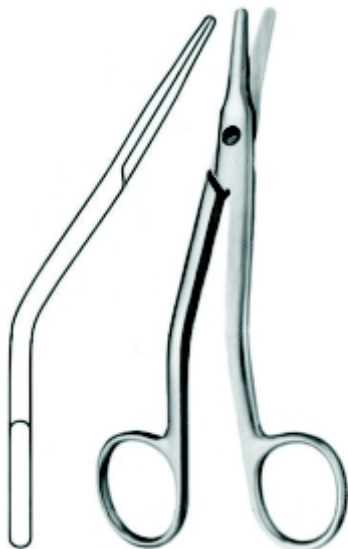

supercut
TC
supercut plus

WALTER COTTLE



16 cm / 6¼"
1250-16
1250-77
1250-177



standard
supercut
TC
supercut plus

COTTLE



16cm / 6¼"
7-0730-16
7-0143-16
1251-36
1251-136



GIUNTA

TC



13.5 cm / 5 3/8"
1251-63



CONVERSE



standard 13.5 cm / 5 3/8"
1243-13



COTTLE MASING



standard

10 cm / 4"
1246-10



10 cm / 4"
1247-10



COTTLE



11.5 cm / 4 1/4"
TC 1249-12



CINELLI



standard

11 cm / 4 3/8"
1251-11

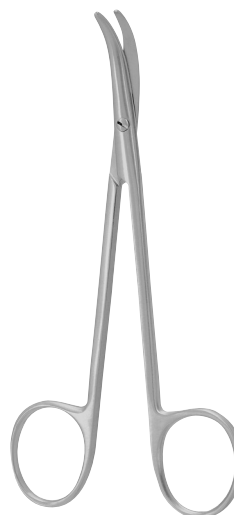

FOMON



standard

12.5 cm / 5"
1251-43



MCINDOE

standard

19 cm / 7½"
1251-18



AUFRICHT

standard
supercut
TC
supercut plus

14 cm / 5½"
1251-34
1251-134
1251-64
1251-164

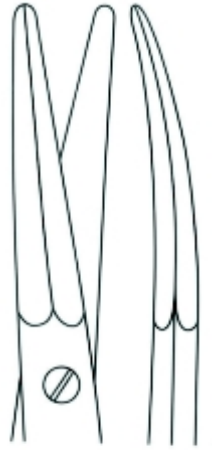

FANOUS

standard
supercut

13 cm / 5 1/8"
1252-14
1252-114



4-0005-03
No.3
12.5 cm



4-0017-07
No.7
16.5 cm / 6½"



04-0019-17
No.7K
12 cm / 4¾"



04-0051-05
15.5 cm / 6 1/8"



1310-45
22.5 cm / 9"



4-0057-01
27 cm / 10¾"



4-0057-03
21 cm / 8¼"



4-0047-04
21 cm / 8¼"



8-0179-14
14.5 cm



ADSON
12 cm 8-0053-12
15 cm 8-0063-15



1,5 mm



ADSON T/C
8-0057-12
12 cm



1 mm



ADSON T/C
8-0057-15
15 cm



1,5 mm



EWALD
8-0041-12
12 cm



1,7 mm



EWALD
8-0239-12
12 cm

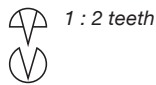

1 : 2 teeth



2 mm



ADSON



1,5 mm

8-0247-12
12 cm



1,5 mm
cross serrated



8-0251-12
12 cm



ADSON
8-0247-15
15 cm



1,5 mm





1 : 2 зуба

ADSON
8-0243-12
12 cm



1,5 mm



1 : 2 зуба

ADSON
8-0243-15
15 cm



2 mm



8-0049-12
12 cm



8-0231-12
12 cm

MICRO ADSON



8-0049-15
15 cm



8-0231-15
15 cm



MICRO ADSON

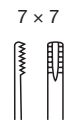

8-0257-12
12 cm

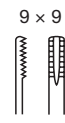

8-0257-15
15 cm

ADSON BROWN



SEMKEN



8-0067-12
12 cm



8-0068-12
12 cm



8-0067-15
15 cm



8-0068-15
15 cm



8-0273-12
12 cm



8-0275-12
12 cm / 4 3/4"



8-0273-15
15 cm



8-0275-15
15 cm / 6"



straight

8-0123-15
15 cm

8-0123-18
18 cm



curved

8-0124-15
15 cm

8-0124-18
18 cm



Пинцет Т/С изолированный
18 cm 8-0175-18
23 cm 8-0175-23



1614-42
12.5 cm

MOSQUITO



1615-42
12.5 cm

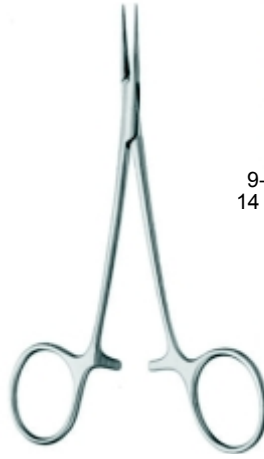

MOSQUITO

9-0079-14
14 cm

9-0083-14
14 cm

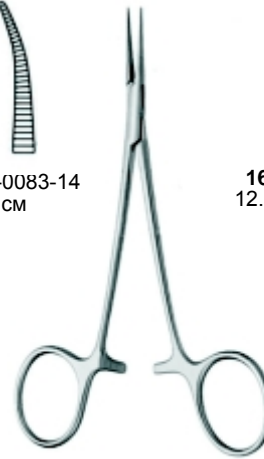

MICRO JACOBSON
(KOSHIMA)

1618-52
12.5 cm

1619-52
12.5 cm



Halsted MOSQUITO

9-0089-12
12 cm

9-0093-12
12 cm

9-0098-13
13 cm

9-0100-13
13 cm



PROVIDENCE HOSPITAL

1630-14
10 cm

1631-14
10 cm

1632-14
12.5 cm

1633-14
12.5 cm



MOSQUITO

9-0079-12
12.5 cm

9-0083-12
12.5 cm

9-0080-12
12.5 cm

9-0084-12
12.5 cm

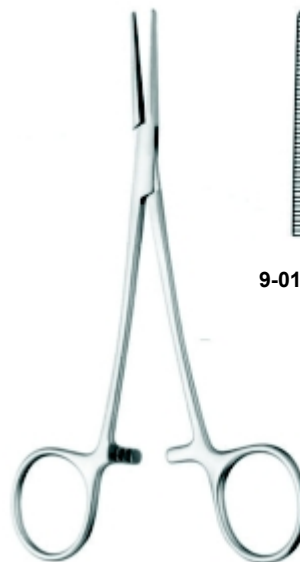

LERICHE 15 cm

9-0171-15

9-0172-15

9-0175-15

9-0176-15

Иглодержатели



Типы твердосплавных вставок на иглодержателях T/C

Иглодержатели отличаются по размеру насечек на твердосплавной пластине.

Измеряется в размере зубца (мм) или количестве зубцов на квадратный дюйм Teeth PSI

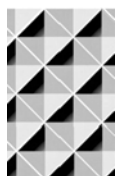

(R) Rough

0.5mm
2,500 tpsi

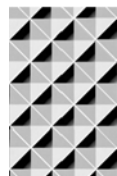

(S) Standard

0.4mm
3,600 tpsi

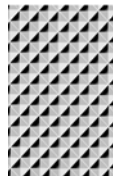

(F) Fine

0.3mm
7,000 tpsi

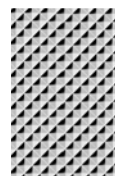

(EF) Extra Fine

0.25mm
10,000 tpsi

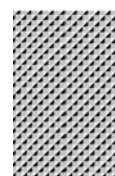

(M) Micro

0.2mm
14,400 tpsi



(S) Smooth

Гладкий

Размер нити

Тип иглодержателя	Вставка	Размер	0/0	1/0	2/0	3/0	4/0	5/0	6/0	7/0	8/0	9/0	10/0	11/0
Vascular, Micro Needle Holder	Diamond								✓	✓	✓	✓	✓	✓
Castroviejo, Nagata, Neurosurgical, Webster	(S) Smooth							✓	✓	✓	✓	✓	✓	✓
Microvascular, Mini-Ryder, Diethrich Ryder, Neivert, Webster, Castroviejo, Giannini	(M) Micro	0,20						✓	✓	✓	✓	✓		
Crile-Wood, Swedish, DeBakey, Intracardiac, Neurosurgical, Derf, Kilner, Ryder, Finocchietto, Gillies	(S) Standard	0,40				✓	✓	✓						
Halsey, Micro Ryder, Heavy Micro Needle Holders	(F) Fine	0,30					✓	✓	✓	✓				
Mayo-Hegar, Mathieu, Bozemann, Hegar, Mathieu, Baumgartner	(R) Rough	0,50		✓	✓	✓								
Gubisch, Convers,	(EF) Extra Fine	0,25						✓	✓	✓	✓			



1708-61
11.5 cm



13-0348-13
13 cm

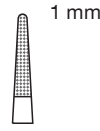

GUBISCH (CONVERSE)
13-0352-12
12.5 cm



DERF T/C
13-0302-12
12.5 cm



HALSEY T/C
13-0346-13
13.5 cm



HALSEY
13-0174-13
13.5 cm

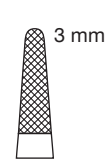

14 cm
13-0388-14

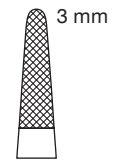

17 cm
13-0388-17

MATHIEU T/C
1714-14



MAYO HEGAR T/C



13-0312-16
16 cm



13-0312-18
18 cm



13-0312-20
20 cm



13-0312-23
23 cm



13-0312-24
24 cm



13-0312-26
26 cm



13-0312-30
30 cm



CRILE WOOD T/C



13-0336-15
15 cm



13-0342-18
18 cm



13-0342-20
20 cm



13-0342-23
23 cm



1 mm
13-0370-15
15 cm

1 mm
13-0370-17
17 cm

Swedish Pattern



1,5 mm
13 cm - 5"
13-0366-13

1,5 mm
15 cm - 6"
13-0366-15

1,5 mm
18 cm - 7"
13-0366-18

Micro-RYDER



GILLIES SLIM
13-0463-14
14.5 cm

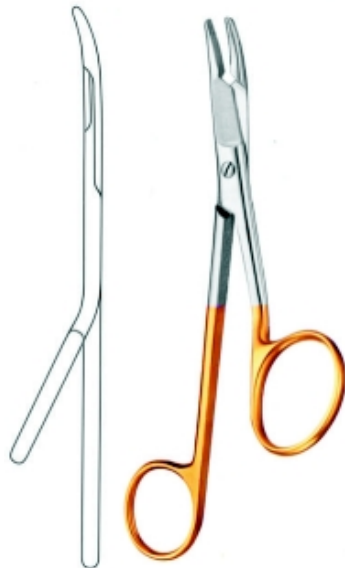

GILLIES
13-0465-16
15.5 cm

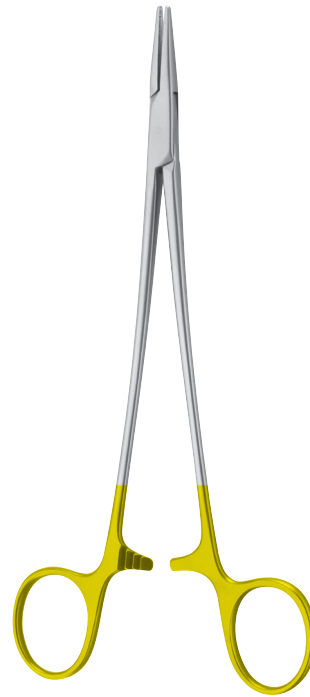

2 mm
15 cm
13-0328-15

2 mm
18 cm
13-0328-18

2 mm
20 cm - 8"
13-0328-20

MICROVASCULAR T/C



Ø 25 mm
280 g
with interchangeable plastic disks

15-1340-18
18.5 cm / 7¼"



Ø 30 mm
350 g
convex / flat

COTTLE
15-1292-19
19 cm / 7½"

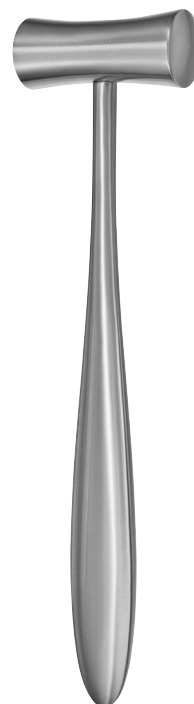

Ø 25 mm
250 g
19 cm – 7½"

1808-20



Ретрактор Saldana
12 см 16 см 20 см

Со световодом 34-0790-10 34-0790-11 34-0790-12

С аспирацией 34-0790-13 34-0790-14 34-0790-15

С аспирацией 34-0790-16 34-0790-17 34-0790-18



Ретрактор Deaver
30 см
11-0538-04



Ретрактор Deaver
30 см
11-0542-02

Распаторы



FREER
19 cm

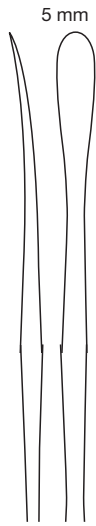

28-0242-18

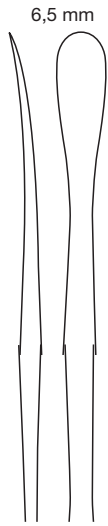

1918-03



COHEN 24 cm
1918-24



WALTER
1918-38
14.5 cm



WILLIGER
16 cm

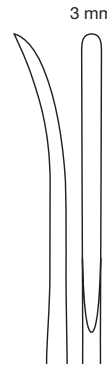

1915-03

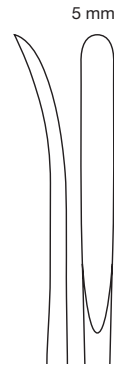

1915-05

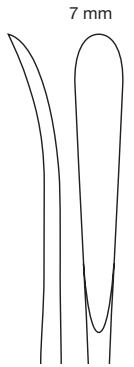

15-0404-16



WILLIGER WALTER
1924-14
14 cm / 5½"



Ø 3 / 2,5 mm



LEMPERT
17 cm / 6¾"



1923-02



1923-03



1923-04



1923-05



1923-06



MCKENTY
15 cm

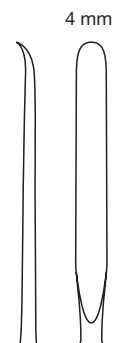

28-0224-04

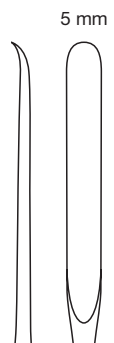

28-0224-05

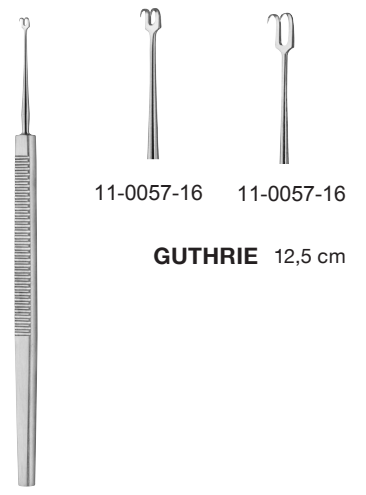
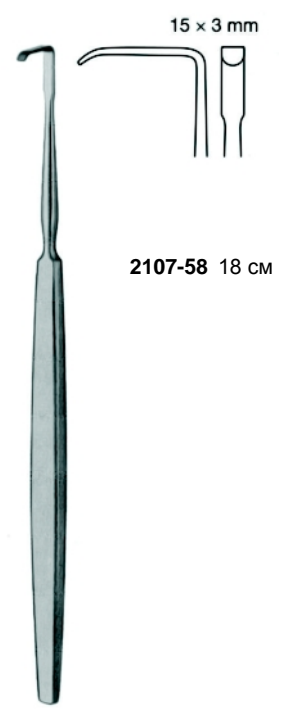
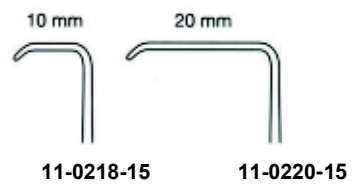
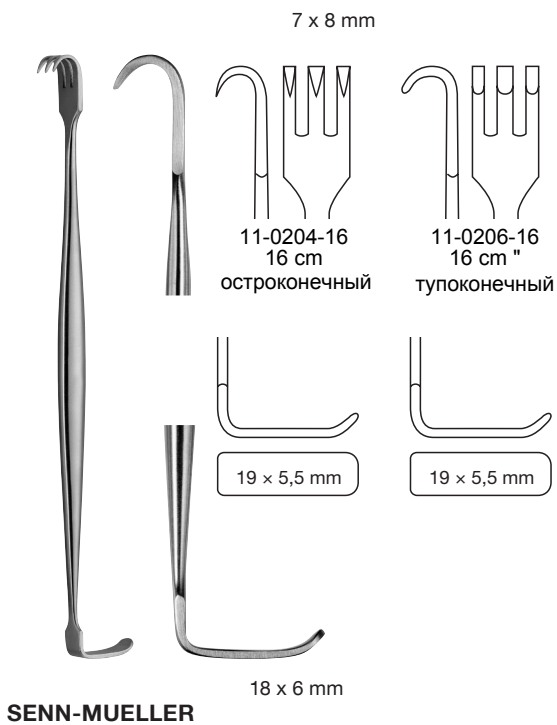

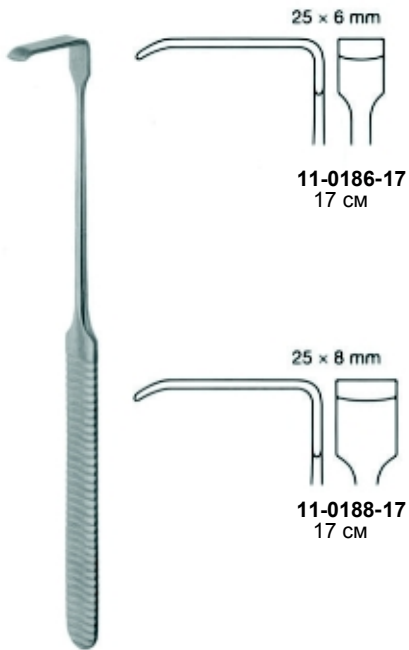

LANGENBECK GREEN

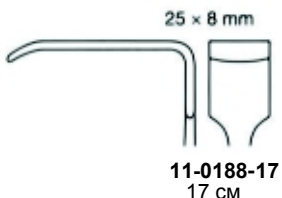
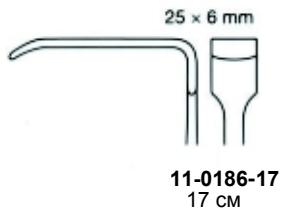

FRAZIER
13 cm

11-0029-13 Остроконечный

11-0030-13 Тупоконечный

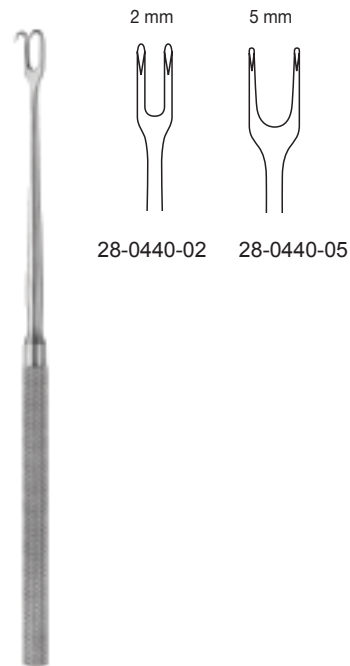

JOSEPH
17 cm

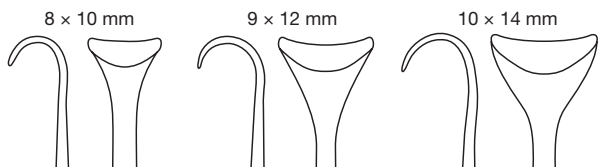
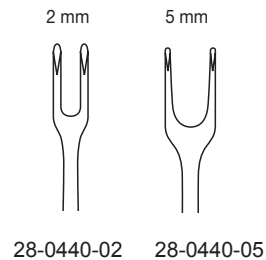

0

1

2

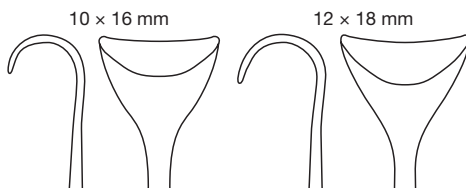

3

4



DESMARRES

Ширина	14 cm
10 mm	11-0164-10
12 mm	11-0164-12
14 mm	11-0164-14
16 mm	11-0164-16
18 mm	11-0164-18



DESMARRES
Изолированный

10 mm	11-0164-10A
12 mm	11-0164-12A
14 mm	11-0164-14A

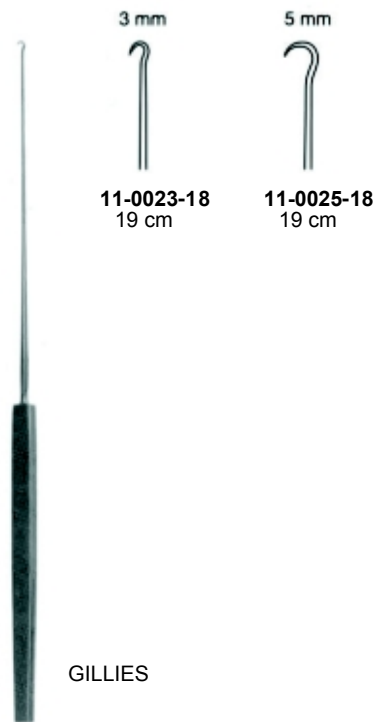

GILLIES

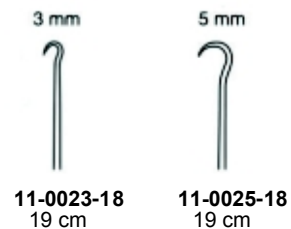

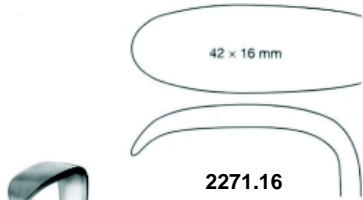

2271.16

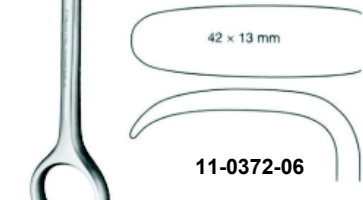

11-0372-06

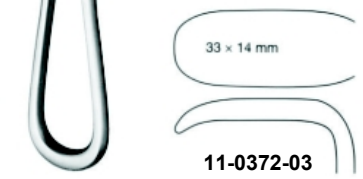

11-0372-03

KOCHE
R21
cm

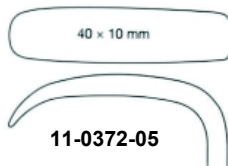

11-0372-05



FARABEUF
11-0266-05
15 cm / 6"

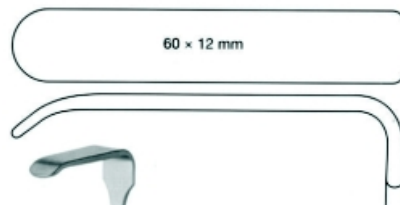

11-0384-07

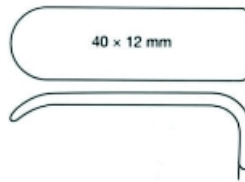

11-0384-06

KOCHER
22 cm



FARABEUF BABY
11-0266-03
12 cm / 4 3/4"



US ARMY изолированный

11-0248-21i
19 cm



US ARMY
11-0248-21
19 cm / 7 1/2"



SOLZ
2490.10
34 см
2490.11
37 см



Атравматический диссектор для маммопластики

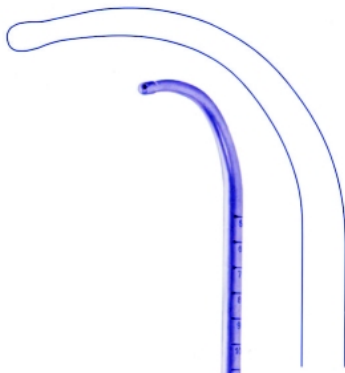

Диссектор крючкообразный

SOLZ
Левый Правый
2490.15 2490.15
36 см

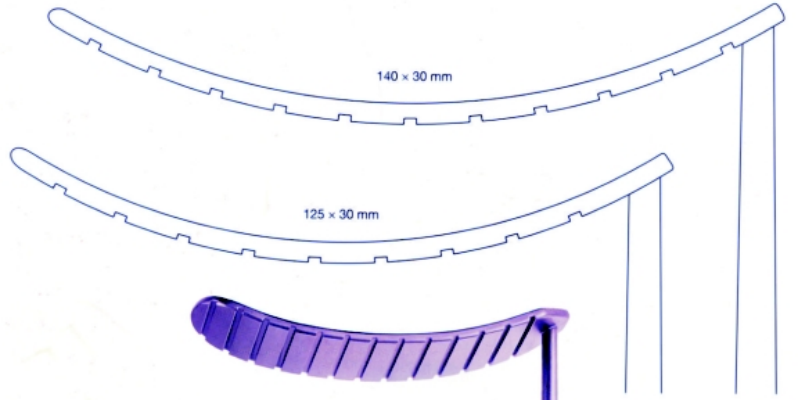

34-1500-01 34-1500-02
12,5 см 14 см



MARX
27 см



Yanoskie
34-0790-43



Aufricht с аспирацией
RT-4501
18 см



Ferreira facelift
34-0637-03
10,5 см
Blade 10,5 x 2 см

Оптоволоконный ретрактор Tebbets
Со световодом и аспирацией



Артикул	Длина [мм]	Ширина [мм]
34-0691-18	90	24
34-0693-18	90	30
34-0694-18	120	24
34-0695-18	150	30
34-0697-18	190	30

- Оптоволоконный световод
- Аспиратор для удаления дыма
- Зеркально отполированная дистальная часть клинка для отражения света внутри кармана



Ferreira
Длина 18.5 см

Ретрактор оптоволоконный Ferreira
Со световодом и аспирацией

Артикул	Длина	Ширина
34-0761-00	90 мм	25 мм
34-0763-00	120 мм	25 мм
34-0769-00	150 мм	30 мм



Ретрактор двухсторонний Breast

120 мм x 70 мм 34-1840-15
70 мм x 50 мм 34-1840-12

Маркер Ареолы Freeman (Режущий)
Артикул

34-0805-30	32mm Ø
34-0805-32	34mm Ø
34-0805-00	36mm Ø
34-0807-00	38mm Ø
34-0809-00	40mm Ø
34-0811-00	42mm Ø
34-0813-00	45mm Ø





Ретрактор для фейслифтинга FREEMAN
 Длина 18 см
34-0607-01 2.16 см Ширина
34-0607-00 3.8 см Ширина



Длина 102 мм,
 клинок 45x9 мм

Носовой ретрактор Maliniac
 34-0633-10



Оптоволоконный кабель

#	Длина	Диаметр
Cable 80	250 мм	3.5мм Ø

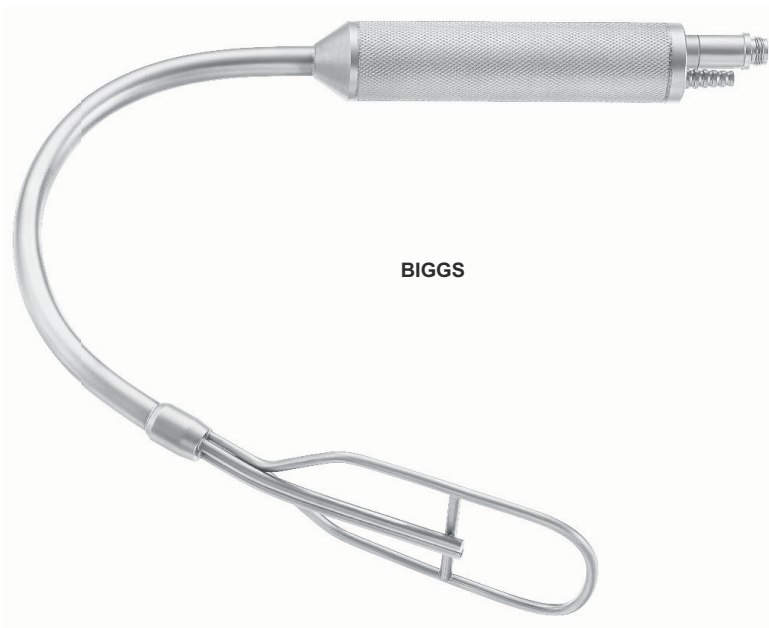

BIGGS

Оптоволоконный ретрактор для
 маммопластики Biggs
 34-0689-30 Ширина клинка 30 мм
 34-0688-30 Ширина клинка 50 мм



Racket Face lift
 34-0688-12
 12 см



Носовой ретрактор Aufricht
Со световодом
Длина 18,5 см
Ширина клинка 7мм



Aufricht Носовой ретрактор
RT-4500



Ретрактор со световодом Feggeira для Фейслифтинга
34-0679-10
Длина Клинка 108 мм, Ширина 22 мм



Freeman Flap Retractor Fiber Optic,
34-0675-00



Freeman Flap Retractor Fiber Optic,
34-0677-20
203mm length, 13mm Wide



OBWEGESER
22.5 cm



2909.41

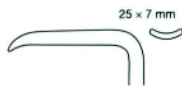

2909.42



2909.43



34-0643-01



34-0645-02



34-0647-01



34-0649-02

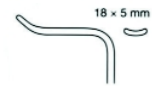

2909.31

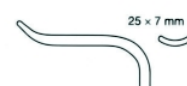

2909.32



2909.33



34-0639-01



34-0641-02



2909.36



2909.37



OBWEGESER
23 cm



KILLIAN со световодом

34-0789-00 35 x 130 mm
34-0791-00 50 x 130 mm
34-0793-00 75 x 130 mm
34-0795-00 90 x 130 mm

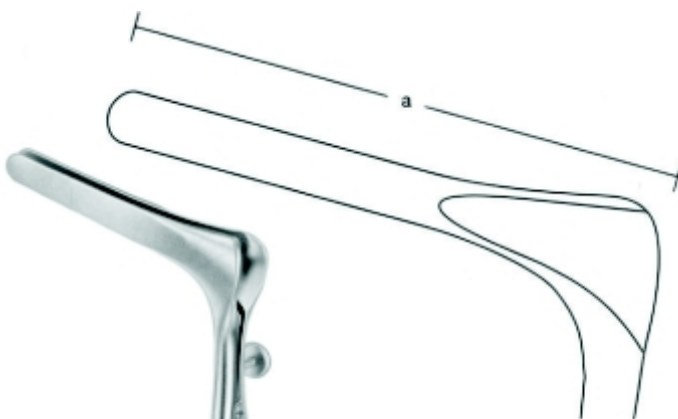

a = 35 mm, #1 28-0048-01
a = 55 mm, #2 28-0046-02
a = 75 mm, #3 28-0048-03
a = 90 mm, #4 28-0048-04

COTTLE 14 cm

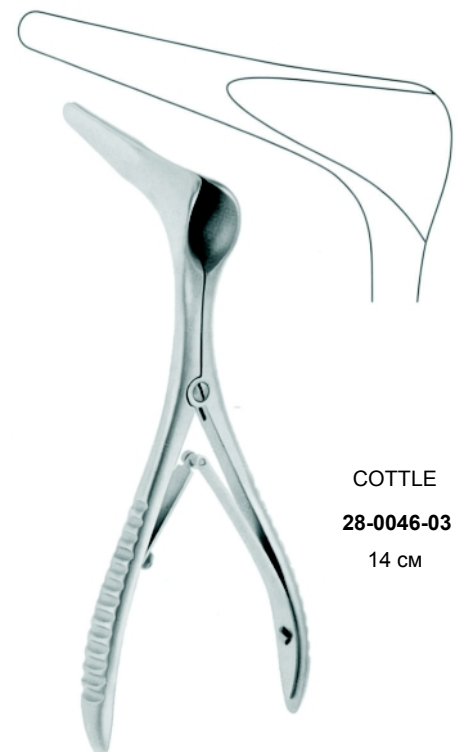

COTTLE
28-0046-03
14 cm

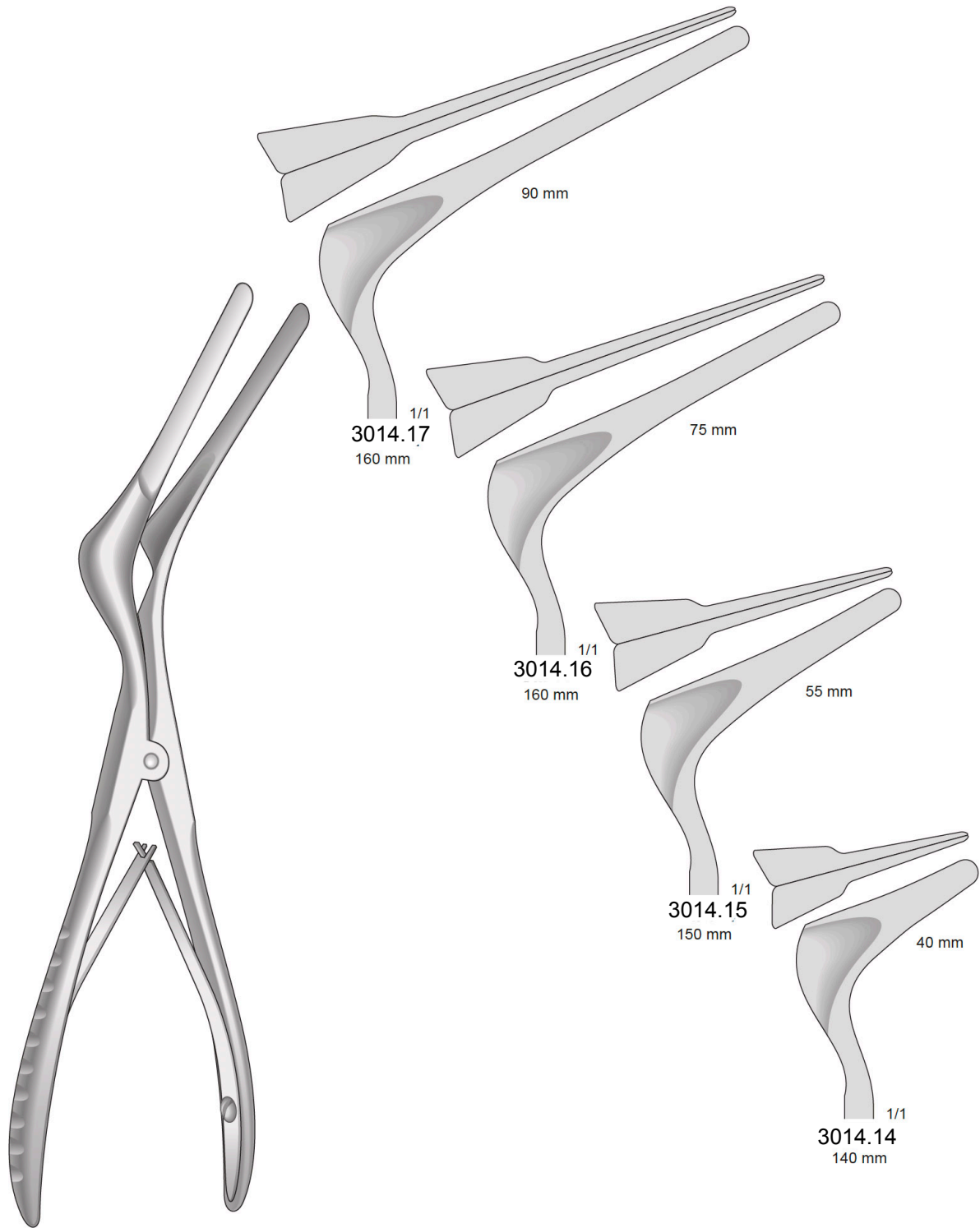



"MOD. WIEN"
14 CM



28-0036-01



28-0036-02



28-0036-03



COTTLE
28-0046-02
13 cm / 5 1/8"



COTTLE (BLACK)

- 35 MM 3011.50
- 55 MM 3011.51
- 75 MM 3011.52
- 90 MM 3011.53

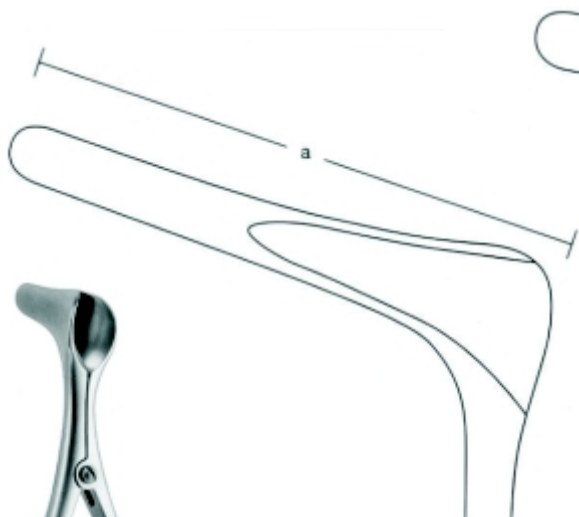

14 cm / 5 1/2"

- a = 35 mm, # 1 28-0042-01
- a = 50 mm, # 2 28-0042-02
- a = 75 mm, # 3 28-0042-03
- a = 90 mm, # 4 28-0042-04



KILLIAN

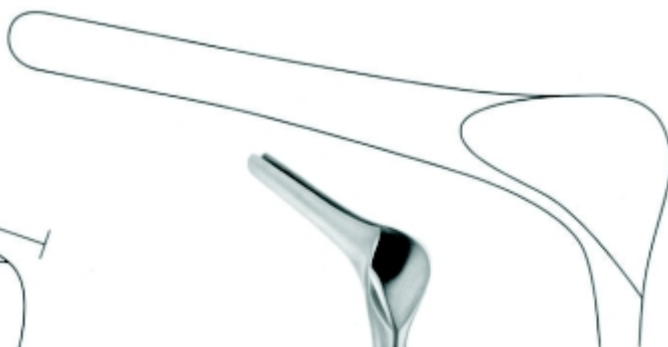

3014.59
14 cm / 5 1/2"

KILLIAN



COTTLE
3067.11
11 cm / 4 3/8"

Нож для слизистой



FREER
28-0200-16
16 cm / 6¼"



BALLENGER
16 cm

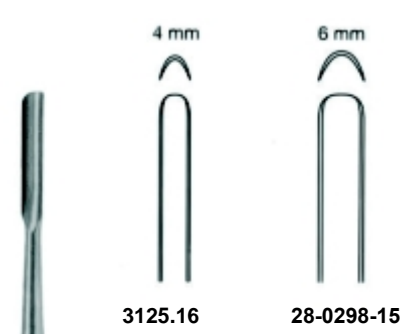
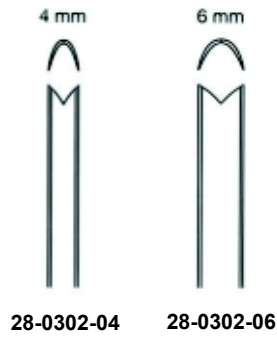

FREER
15.5 cm

Отсос-Распаторы



GORNEY
4133.93
20 cm / 8"



GUBISCH
4133.94
20 cm / 8"

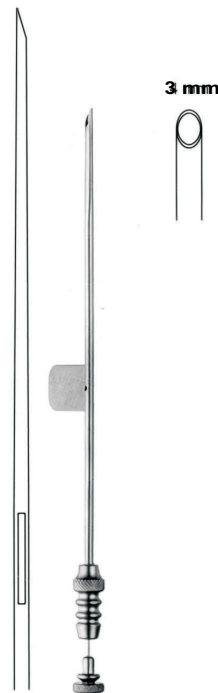

GUBISCH
4133.97
17cm / 6¾"



28-0274-21
20 cm / 8"

		Прямой	Изогнутый вверх 45°	Изогнутый вверх 90°
Со стандартной рабочей частью				
3,0 mm		25-0510-01	25-0512-01	25-0514-01
3,6 mm		25-0510-02	25-0512-02	25-0514-02
4,2 mm		25-0510-03	25-0512-03	25-0514-03
4,8 mm		25-0510-04	25-0512-04	3245.14
5,6 mm		25-0510-05	3244.15	3245.15
Щипцы BLAKESLEY 12 cm - 4 3/4"				
		С тонкой рабочей частью		
3,0 mm			3244.71	3244.81
3,6 mm			3244.72	3244.82
4,2 mm			3244.73	3244.83
4,8 mm			3244.74	3244.84
5,6 mm			3244.75	3244.85

		Прямой	Изогнутый вверх 45°	Изогнутый вверх 90°
BLAKESLEY 11 см Деликатные				
3,0 mm		3244.59	3244.60	3244.61

		прямой	изогнутый вверх 45°
11,5 cm - 4 1/2"			
Кусачие Щипцы BLAKESLEY			
2,0 mm		28-0134-01	3244.35
2,5 mm		28-0134-02	3244.76
3,0 mm		28-0134-03	3244.37



FOMON 17 cm
28-0444-16



NEIVERT 19 cm
28-0452-20

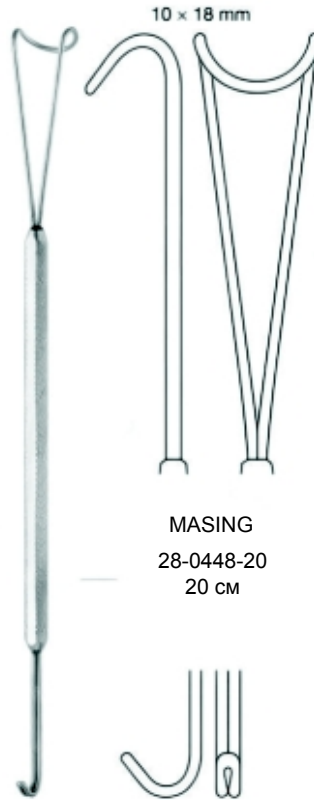

MASING
28-0448-20
20 cm

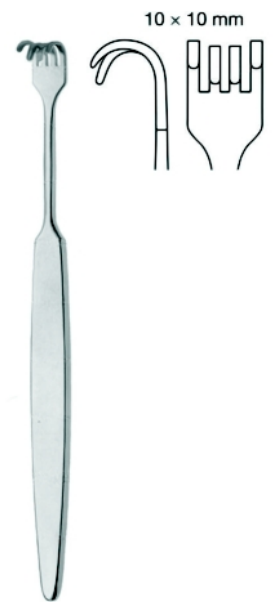

COTTLE
3301.44
15 cm / 6"



COTTLE
15 cm / 6"



28-0460-14



28-0462-14



28-0464-14



OBWEGESSER

34-0665-17



FREEMAN
10 cm

34-0605-10



MILARD (COTTLE)

3301.23

5.5 cm / 2 1/8"



COTTLE
3304.15
 15 cm / 6"

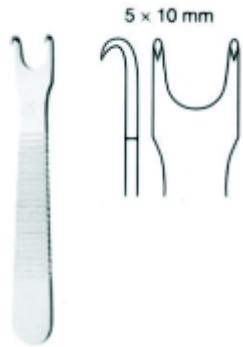

KILNER
 28-0472-08
 10 cm / 4"



COTTLE
 28-0468-16
 14 cm / 5½"



COTTLE
3305.16
 15 cm / 6"



3306.14

AUFRICHT WALTER
 13.5 cm / 5 3/8"

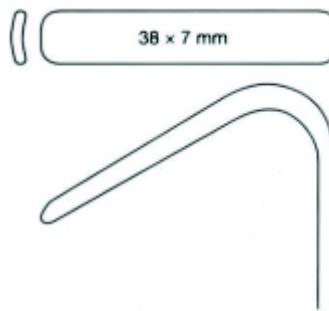

3306.15

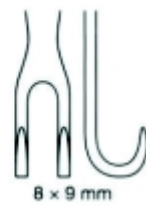

3306.17
 13.5 cm / 5 3/8"

AUFRICHT

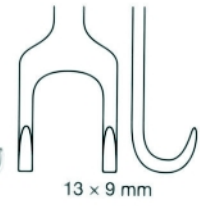



3306.30

18.5 cm / 7 1/4"

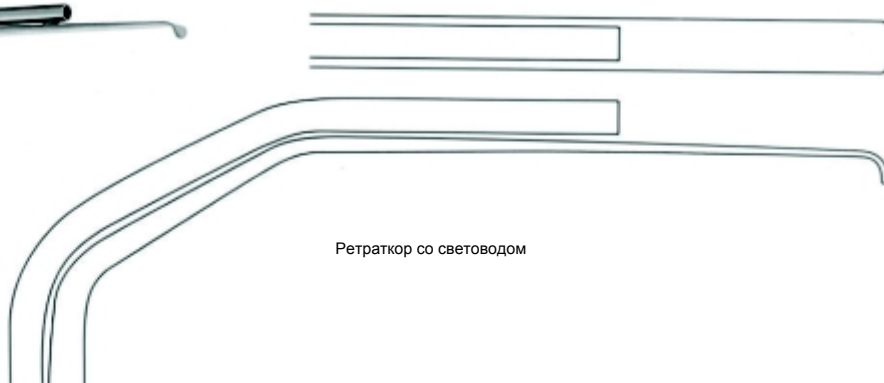

Ретрактор со световодом



50 x 6/12 mm

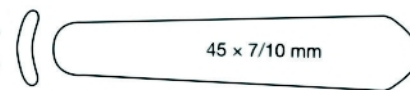

45 x 7/10 mm

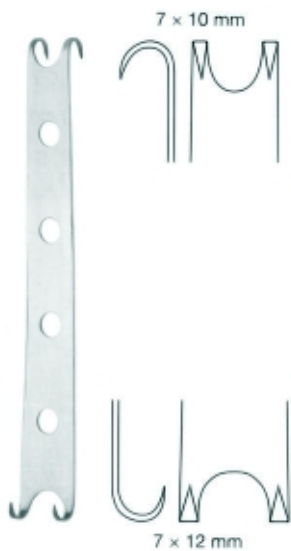

7 x 10 mm

7 x 12 mm

CONVERSE

28-0476-12

12 cm / 4 3/4"

GUBISCH AUFRICHT

3310.17

17 cm / 6 3/4"

AUFRICHT

28-0480-16

18 cm / 7 1/8"



COTTLE
28-0177-01
14 cm



JOSEPH
28-0188-14
15 cm



COTTLE
28-0196-14
14 cm



JOSEPH
3413.16
16 cm / 6 1/4"



CONVERSE
28-0184-15
15 cm



COTTLE
28-0176-01
14 cm



JOSEPH
28-0356-01
12.5 cm

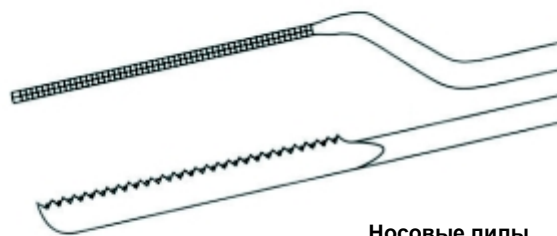
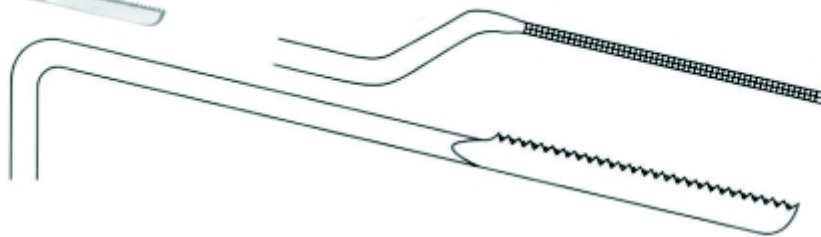

Носовые пилы

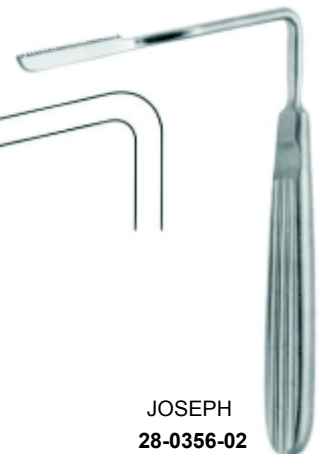

JOSEPH
28-0356-02
12.5 cm



JOSEPH
17 cm



28-0360-01
left



28-0360-02
right

Носовые пилы



JOSEPH
3519.24
17 cm / 6 3/4"

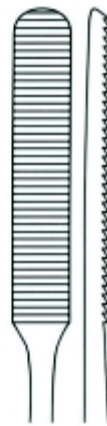

COTTLE
28-0408-21
21 cm



34-0845-21



34-0843-21



34-0841-21

COTTLE

со вставкой из карбида
вольфрама

20.5 cm



MALTZ
28-0388-02
18.5 cm

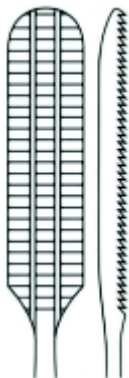

3523.47
19.5 cm

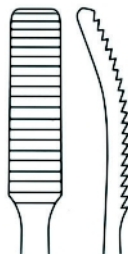

AUFRIGHT
С алмазным напылением
34-0853-22
20cm



FOMON
Двухсторонний рашпиль
с алмазным напылением
34-0857-21
21cm



LEWIS
со вставкой из карбида
вольфрама
34-0855-21
20cm

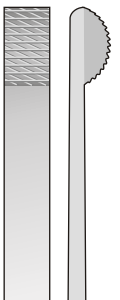

Режущие вниз

Режущий вверх



3525.26
21 cm / 8¼"



28-0412-02
21 cm / 8¼"

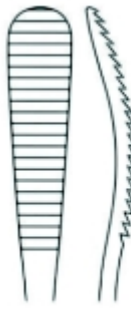

28-0412-01
21 cm / 8¼"

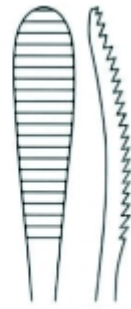

CONVERSE
3525.65
18.5 cm / 7¼"



MASING
3525.70
21 cm / 8¼"

AUFRICHT

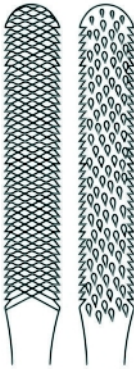

FOMON
28-0376-21
22 cm / 8¾"

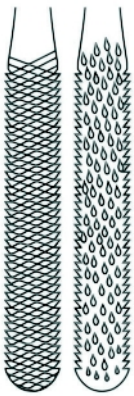

fine



MASING
3525.71
21 cm / 8¼"

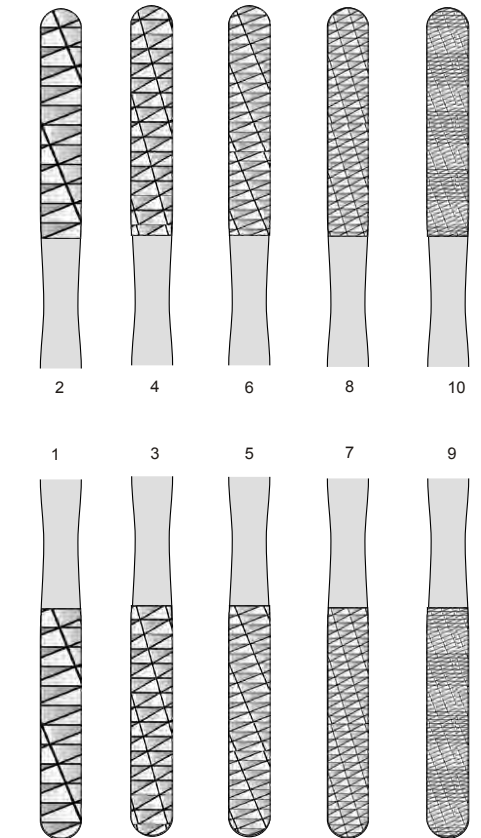

28-0364-12 **28-0364-34** **28-0364-56** **28-0364-78** **28-0364-90**

GUBISCH FOMON

20 cm / 8"

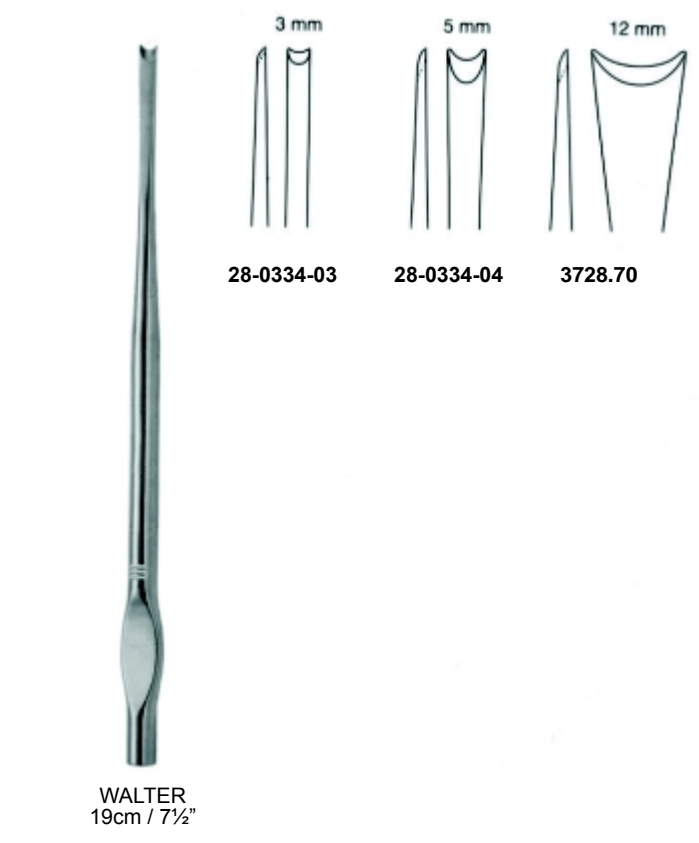
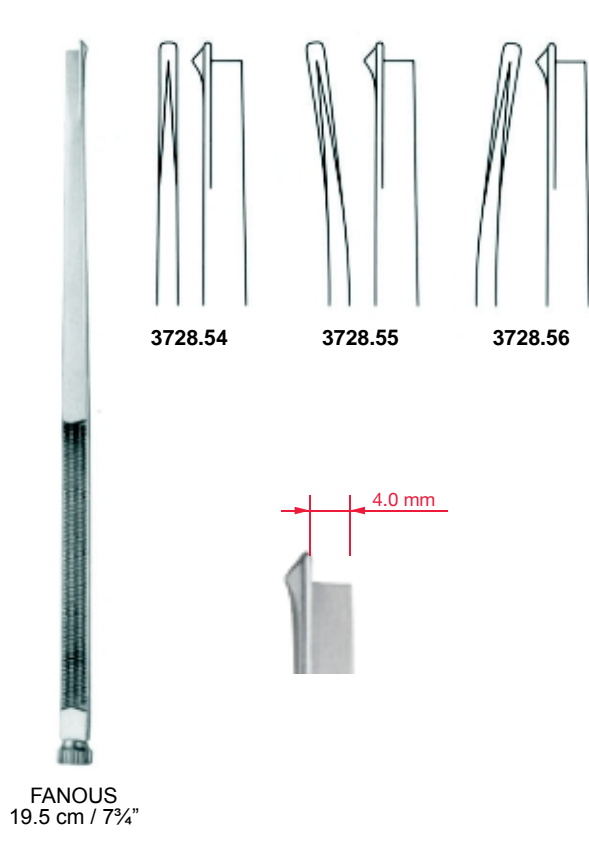
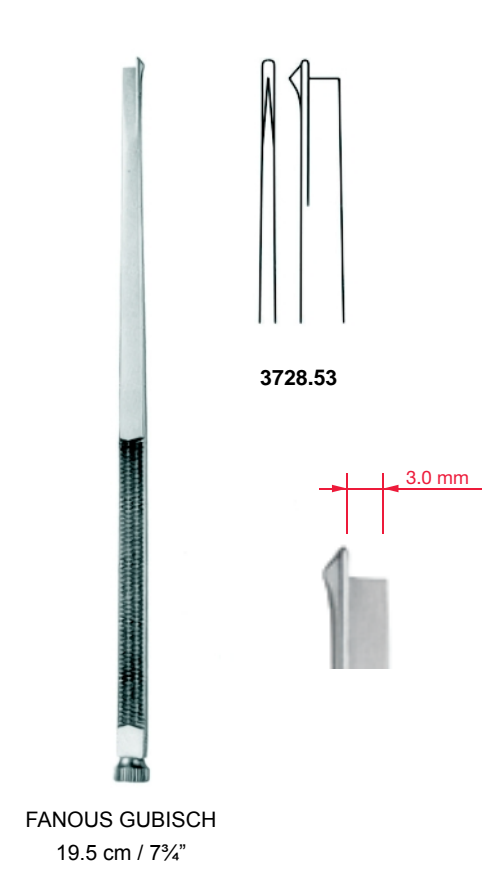
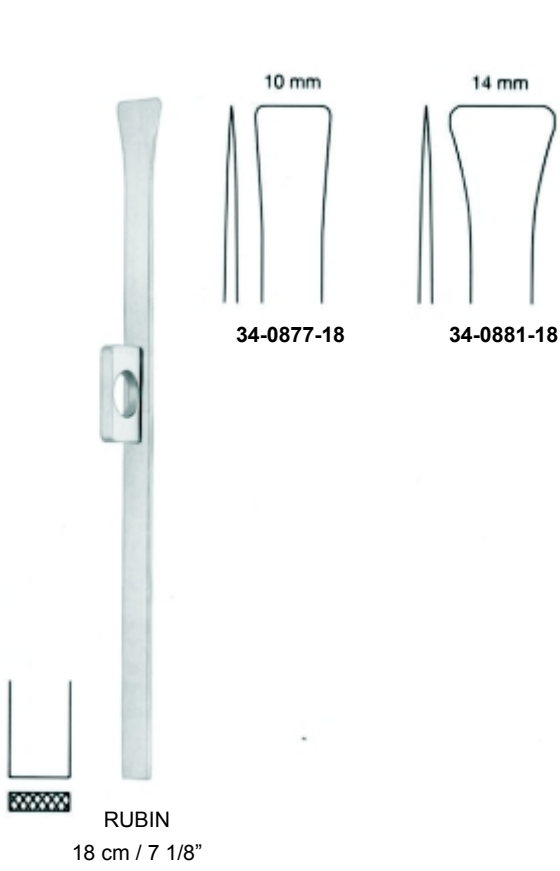



	18 cm - 7"
2 mm	OS 1402
3 mm	OS 1403

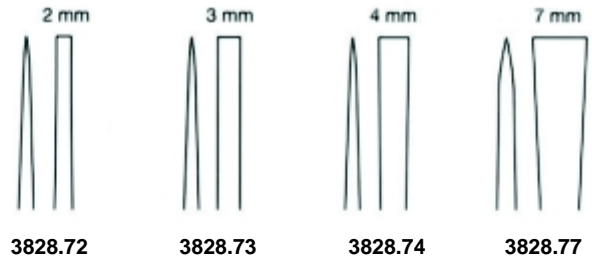

3828.72 3828.73 3828.74 3828.77

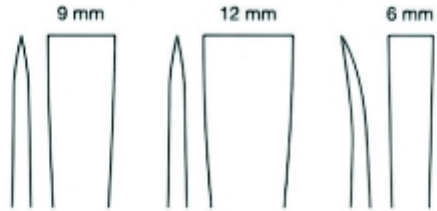

3828.79 3828.82 3828.86

WALTER
19cm / 7½"

Gubisch



3828.75



3828.80

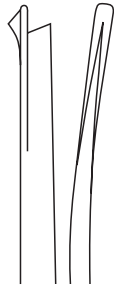

3828.85

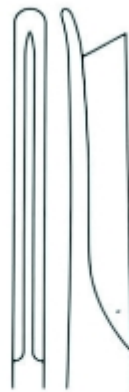
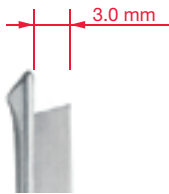

28-0339-02



28-0339-01

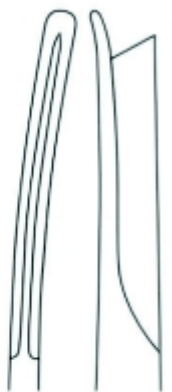

28-0339-03

SILVER
18 cm / 7 1/8"

SCHROM
19.5 cm / 7¾"

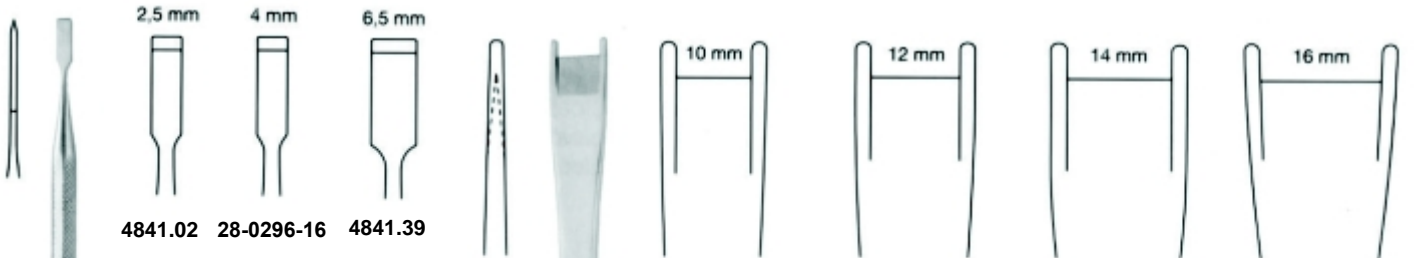

Freer 15 cm

28-0342-10

28-0342-12

28-0342-14

28-0342-16

CINELLI
16 cm

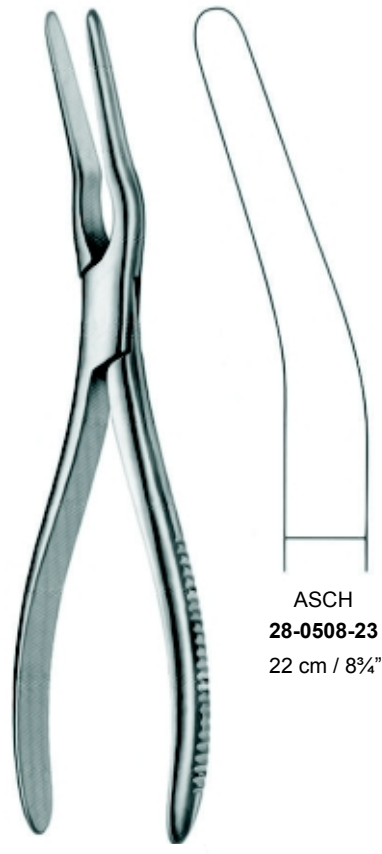

ASCH
28-0508-23
22 cm / 8 3/4"



COTTLE FOMON
28-0504-22
21 cm / 8 1/4"



RUBIN
28-0516-20 T/C
20 cm



RUBIN 20 cm

Размягчитель хряща COTTLE



4934.70
65 x 30 x 30 mm



28-0236-19
18 cm / 7 1/8"

COTTLE



15-0492-20
18 cm

COTTLE

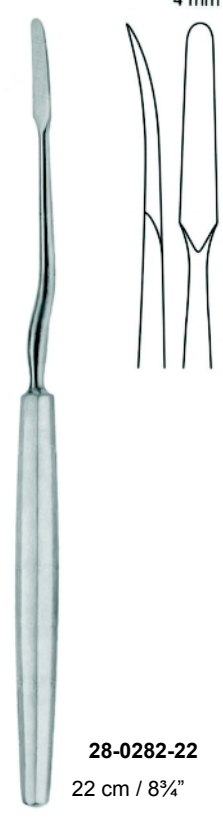

28-0282-22
22 cm / 8 3/4"

JOSEPH MASING



4231.55
18 cm / 7 1/8"

OBWEGESER
17.5 cm / 7"



11-0670-17



4636.39
OBWEGESER
17.5 cm / 7"



4636.40



11-0678-06
OBWEGESER
17.5 cm



11-0678-06



11-0678-07



11-0678-09



11-0678-11

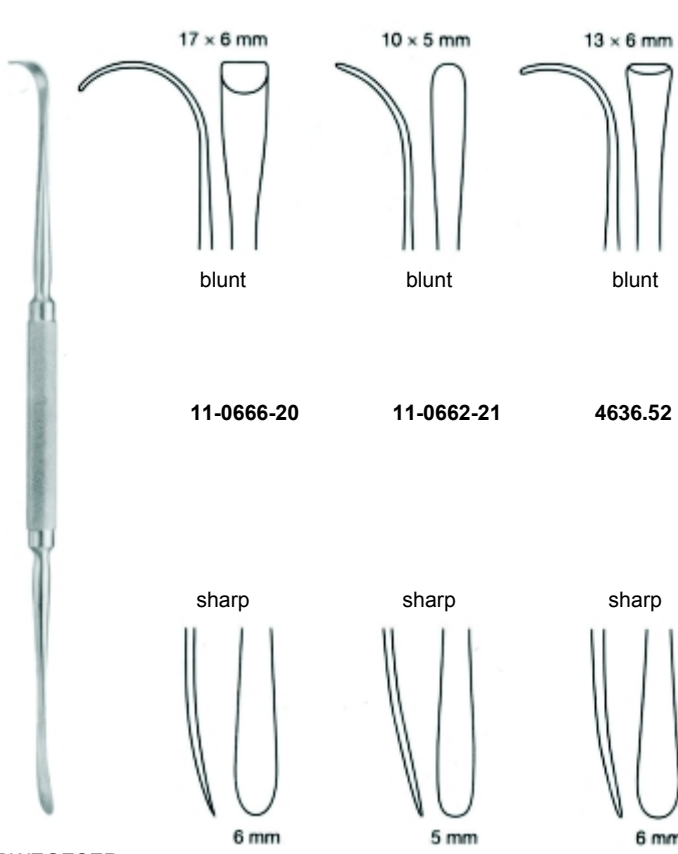

11-0666-20

11-0662-21

4636.52

OBWEGESER
FREER
21 cm / 8 1/4"

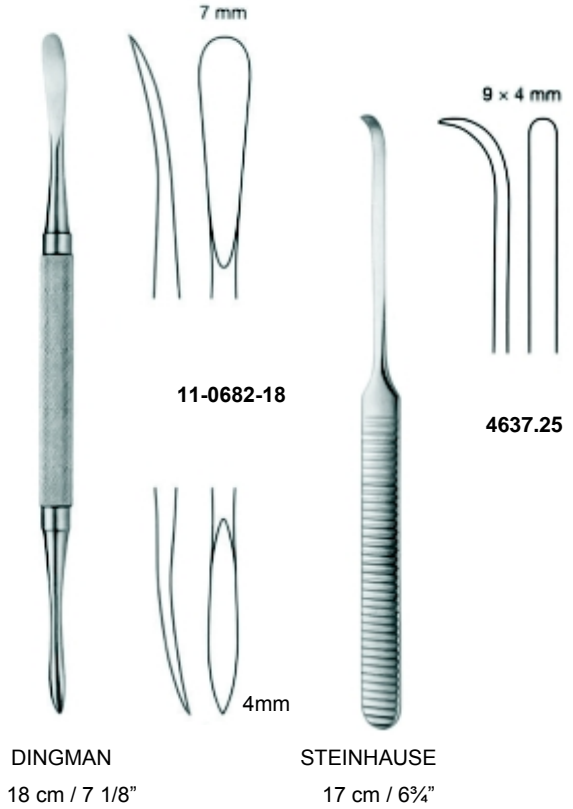

11-0682-18

4637.25

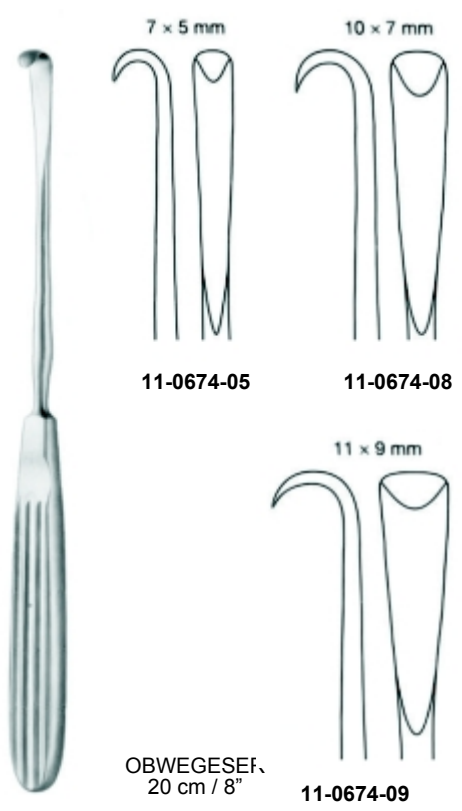
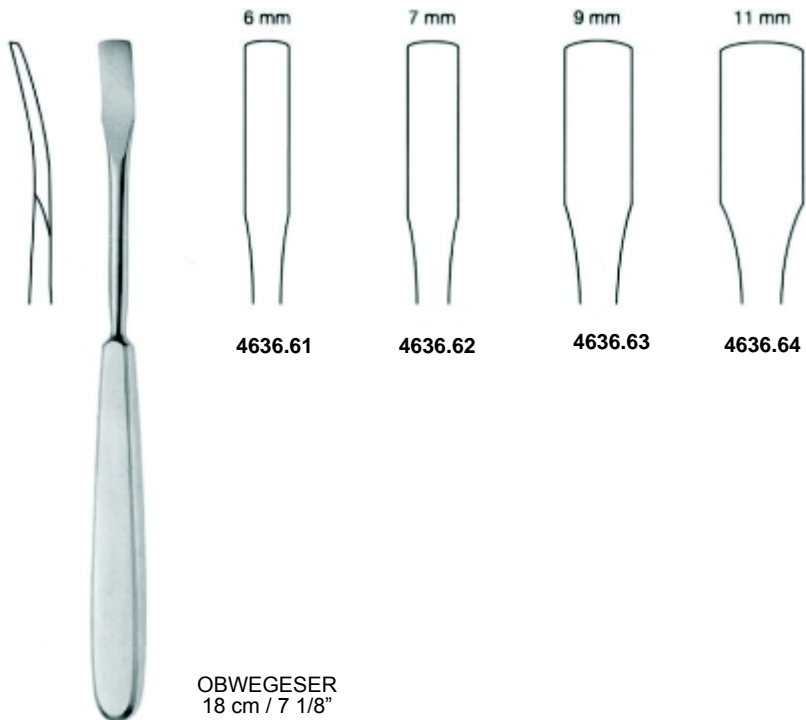



25 cm / 10"

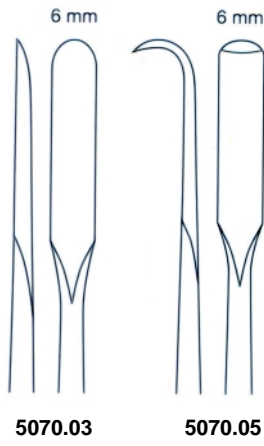

25 cm / 10"

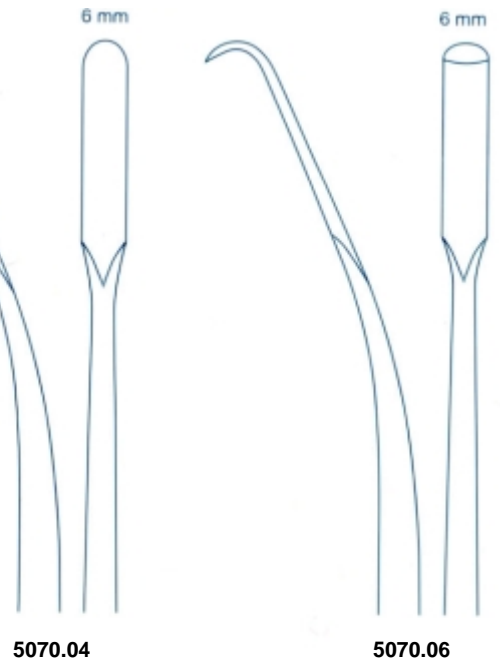

5070.08
25 cm / 10"

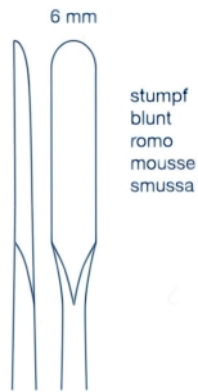

Dissectors
Disectores
Dissecteurs
Dissettori



5070.09
25 cm / 10"

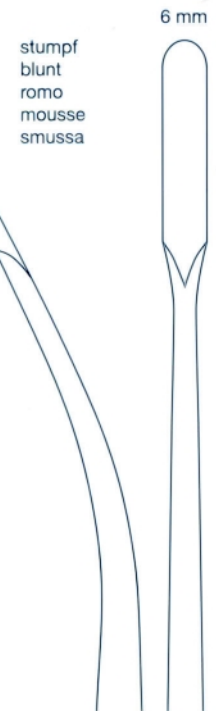

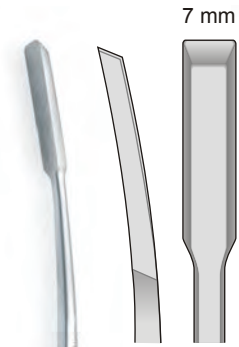

Frontotemporal Dissector
ED 20.01
24cm/9 1/2" Curved 7mm wide



Periosteal Dissector
ED 20.02
24cm/9 1/2" S - Shaped 9mm wide

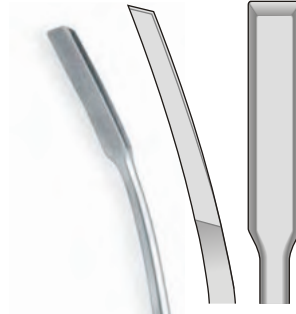

Frontoglabellar Dissector
ED 20.03
26cm/10 1/2" S - Shaped 7mm wide



Periosteal Dissector
ED 20.04
25cm/9 3/4" Curved 9mm wide

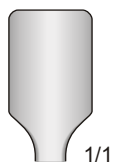

Zygomatic Arch Elevator
ED 20.05
22.5cm/8 3/4" Straight 5mm wide

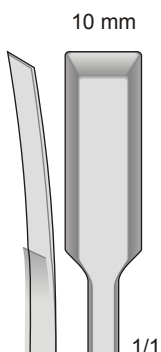

Temporal Line Dissector
ED 20.06
23.5cm/ Straight 10mm wide



Scalp Elevator
ED 20.07
25.5 cm Curved 12mm wide



Scalp Elevator
ED 20.08
24 cm Half Curved with angled tip 12mm wide



Orbital Rim Dissector
ED 20.09
24 cm Half Curved



Flap Dissector
ED 20.10
22.5 cm Curved 6mm wide



Arcus Marginalis Dissector
ED 20.11
24 cm S - изогнутый ширина 8 мм



5170.45
27.5 cm



5270.59
27.5 cm

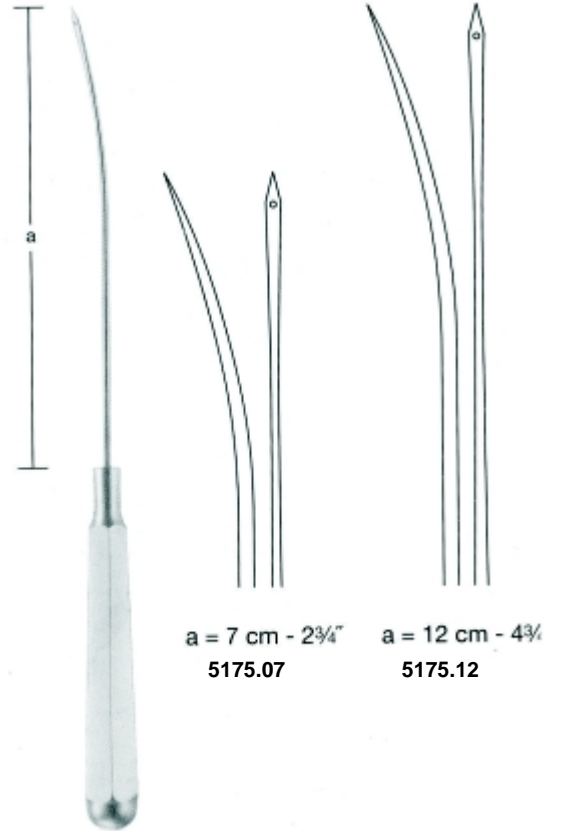

5175.07
a = 7 cm - 2 $\frac{3}{4}$ "

5175.12
a = 12 cm - 4 $\frac{3}{4}$ "

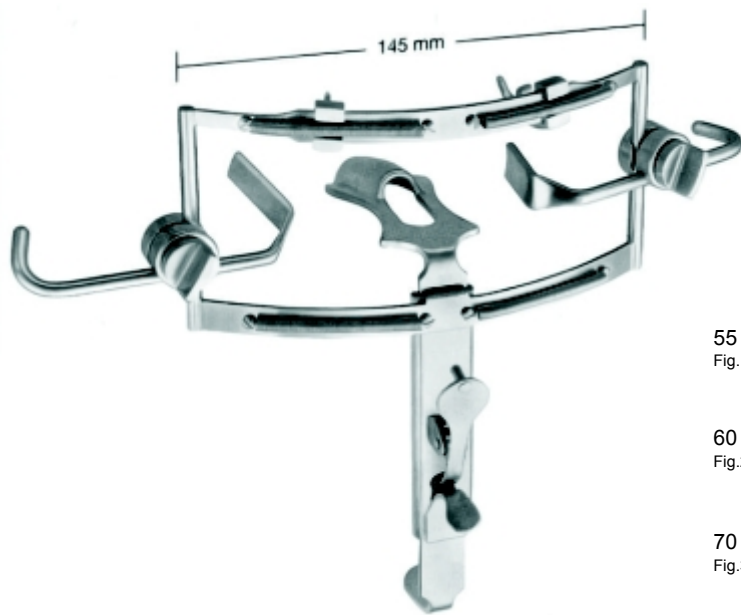

DINGMAN
5418.00



5418.11
55 x 25 mm
Fig.1

5418.12
60 x 27 mm
Fig.2

5418.13
70 x 30 mm
Fig.3



Ретрактор Aufricht с аспирацией 18 см
34-1040-18

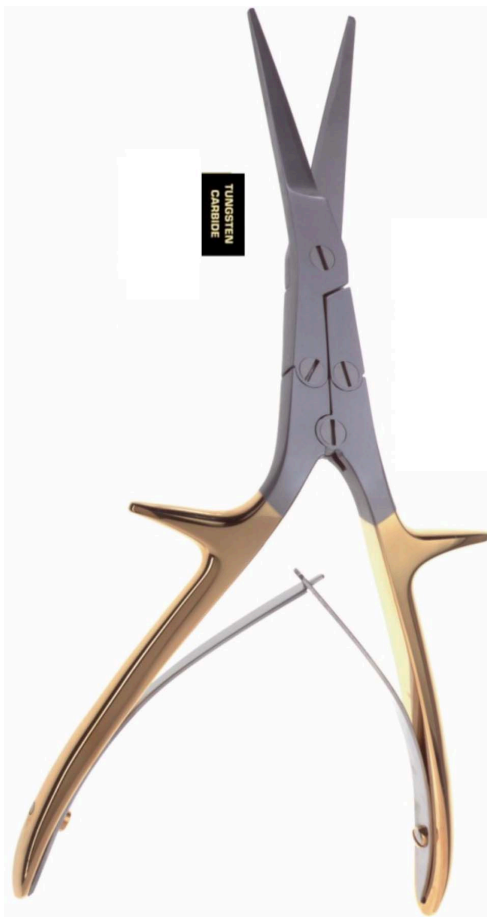

Gorney T/C 20,5 см
34-0040-20



ELMED T/C
13-1001-15
15 см



Trepstat

17 см	34-0040-25
19 см	34-0040-21
20,5 см	34-0040-22

Маркер Ареолы SOLZ

Артикул

2390-20	36mm Ø
2390-23	38mm Ø
2390-24	40mm Ø
2390-25	42mm Ø
2390-26	45mm Ø



Пластика Sheen
34-7010-00

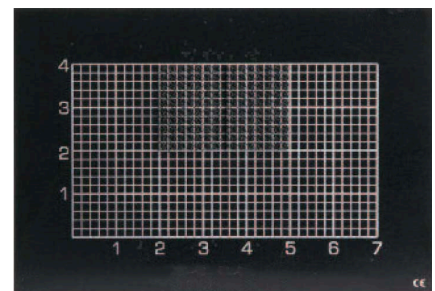

ТРАНСФЕР LUER-LUER



ДИАМЕТР	АРТИКУЛ
1 mm	34-2000-01
1,4 mm	34-2000-02
2 mm	34-2000-15

ЭМУЛЬСИФИКАТОР

Три сменные сетки в комплекте



ЗАМОК ШПРИЦЕВОЙ

10 мл 20 мл 50 мл



ОБЪЁМ	АРТИКУЛ
10 ml	34-2000-10
20 ml	34-2000-20
50 ml	34-2000-50

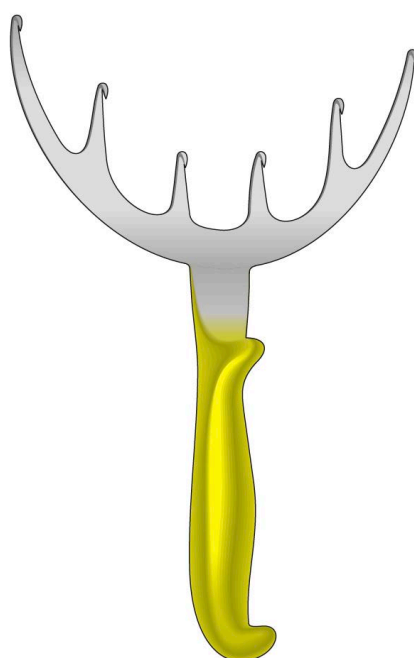

34-0790-45
Freeman
180 мм

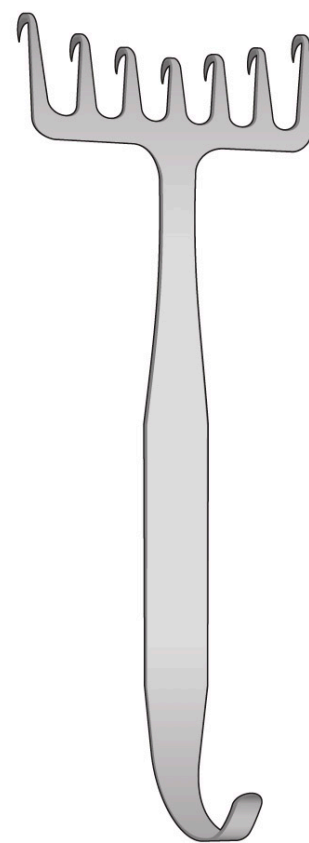

34-0790-44
Coronal
180 мм



McColumn-Dingman
34-0799-20 38 см
34-0799-21 41 см



КАНЮЛЯ С РУЧКОЙ



КАНЮЛЯ С РАЗЪЕМОМ

LUER LOCK



Mercedes

Mercedes Cannula

Три отверстия по кругу
КАНЮЛЯ С РУЧКОЙ



ДИАМЕТР	ДЛИНА	АРТИКУЛ
3 mm	15 cm	34-1064-31
3 mm	20cm	34-1064-32
3 mm	25 cm	34-1064-33
3 mm	30 cm	34-1064-34
4 mm	20 cm	34-1064-35
4 mm	25cm	34-1064-36
4 mm	30 cm	34-1064-37
4 mm	32 cm	34-1064-38
4 mm	35 cm	34-1064-39
5 mm	20 cm	34-1064-40
5 mm	25 cm	34-1064-41
5 mm	30 cm	34-1064-42
5 mm	32 cm	34-1064-43
5 mm	36 cm	34-1064-28
6 mm	30 cm	34-1064-29
6 mm	35 cm	34-1064-30

Mercedes Cannula

Три отверстия по кругу
КАНЮЛЯ LUER LOCK



ДИАМЕТР	ДЛИНА	АРТИКУЛ
2 mm	10 cm	34-1064-10
2 mm	12cm	34-1064-15
2 mm	15 cm	34-1064-20
2 mm	20 cm	34-1064-21
3 mm	15 cm	34-1064-22
3 mm	20cm	34-1064-23
3 mm	25 cm	34-1064-24
4 mm	20 cm	34-1064-25
4 mm	25 cm	34-1064-26
4 mm	30 cm	34-1064-27



TRIPORT Cannula

Три отверстия в ряд
КАНЮЛЯ С РУЧКОЙ



ДИАМЕТР	ДЛИНА	АРТИКУЛ
3 mm	15 cm	34-1064-45
3 mm	20cm	34-1064-46
3 mm	25 cm	34-1064-47
3 mm	30 cm	34-1064-48
4 mm	20 cm	34-1064-49
4 mm	25cm	34-1064-50
4 mm	30 cm	34-1064-51
4 mm	32 cm	34-1064-52
4 mm	35 cm	34-1064-53
5 mm	20 cm	34-1064-54
5 mm	25 cm	34-1064-55
5 mm	30 cm	34-1064-56
5 mm	32 cm	34-1064-67
5 mm	36 cm	34-1064-58
6 mm	32 cm	34-1064-59

TRIPORT Cannula

Три отверстия в ряд
КАНЮЛЯ LUER LOCK



ДИАМЕТР	ДЛИНА	АРТИКУЛ
2 mm	10 cm	34-1064-60
2 mm	12cm	34-1064-61
2 mm	15 cm	34-1064-62
2 mm	20 cm	34-1064-63
3 mm	15 cm	34-1064-64
3 mm	20cm	34-1064-65
3 mm	25 cm	34-1064-66
4 mm	25 cm	34-1064-67



LAS VEGAS Cannula

Три отверстия в виде
пирамиды
КАНЮЛЯ С РУЧКОЙ



ДИАМЕТР	ДЛИНА	АРТИКУЛ
3 mm	15 cm	34-1065-09
3 mm	20cm	34-1065-10
3 mm	25 cm	34-1065-11
3 mm	30 cm	34-1065-12
4 mm	20 cm	34-1065-13
4 mm	25cm	34-1065-14
4 mm	30 cm	34-1065-15
4 mm	32 cm	34-1065-16
4 mm	35 cm	34-1065-17
5 mm	20 cm	34-1065-18
5 mm	25 cm	34-1065-19
5 mm	30 cm	34-1065-20

LAS VEGAS Cannula

Три отверстия в виде
пирамиды
КАНЮЛЯ LUER LOCK



ДИАМЕТР	ДЛИНА	АРТИКУЛ
2 mm	10 cm	34-1065-01
2 mm	12cm	34-1065-02
2 mm	15 cm	34-1065-03
2 mm	20 cm	34-1065-04
3 mm	15 cm	34-1065-05
3 mm	20cm	34-1065-06
3 mm	25 cm	34-1065-07
4 mm	25 cm	34-1065-08



КАНЮЛЯ С РУЧКОЙ



КАНЮЛЯ С РАЗЪЕМОМ

LUER LOCK



ACCELERATOR Cannula

Три отверстия в виде обратной пирамиды
КАНЮЛЯ С РУЧКОЙ



ДИАМЕТР	ДЛИНА	Артикул
3 mm	15 cm	34-1065-45
3 mm	20cm	34-1065-46
3 mm	25 cm	34-1065-47
3 mm	30 cm	34-1065-48
4 mm	20 cm	34-1065-49
4 mm	25cm	34-1065-50
4 mm	30 cm	34-1065-51
4 mm	32 cm	34-1065-52
4 mm	35 cm	34-1065-53
5 mm	20 cm	34-1065-54
5 mm	25 cm	34-1065-55
5 mm	30 cm	34-1065-56

ACCELERATOR Cannula

Три отверстия в виде обратной пирамиды
КАНЮЛЯ LUER LOCK



ДИАМЕТР	ДЛИНА	Артикул
2 mm	10 cm	34-1065-37
2 mm	12cm	34-1065-38
2 mm	15 cm	34-1065-39
2 mm	20 cm	34-1065-40
3 mm	15 cm	34-1065-41
3 mm	20cm	34-1065-42
3 mm	25 cm	34-1065-43
4 mm	25 cm	34-1065-44



Agressive Harvester Cannula

Отверстия с выступами наружу
КАНЮЛЯ С РУЧКОЙ



ДИАМЕТР	ДЛИНА	Артикул
3 mm	15 cm	34-1064-76
3 mm	20cm	34-1064-77
3 mm	25 cm	34-1064-78
3 mm	30 cm	34-1064-79
4 mm	20 cm	34-1064-80
4 mm	25cm	34-1064-81
4 mm	30 cm	34-1064-82
5 mm	32 cm	34-1064-83

Agressive Harvester Cannula

Отверстия с выступами наружу
КАНЮЛЯ LUER LOCK



ДИАМЕТР	ДЛИНА	Артикул
2 mm	10 cm	34-1064-68
2 mm	12cm	34-1064-69
2 mm	15 cm	34-1064-70
2 mm	20 cm	34-1064-71
3 mm	15 cm	34-1064-72
3 mm	20cm	34-1064-73
3 mm	25 cm	34-1064-74
4 mm	25 cm	34-1064-75



Semi Agressive Harvester Cannula

Отверстия с выступами внутрь
КАНЮЛЯ С РУЧКОЙ



ДИАМЕТР	ДЛИНА	Артикул
3 mm	15 cm	34-1064-92
3 mm	20cm	34-1064-93
3 mm	25 cm	34-1064-94
3 mm	30 cm	34-1064-95
4 mm	20 cm	34-1064-96
4 mm	25cm	34-1064-97
4 mm	30 cm	34-1064-98
5 mm	32 cm	34-1064-99

Semi Agressive Harvester Cannula

Отверстия с выступами внутрь
КАНЮЛЯ LUER LOCK



ДИАМЕТР	ДЛИНА	Артикул
2 mm	10 cm	34-1064-84
2 mm	12cm	34-1064-85
2 mm	15 cm	34-1064-86
2 mm	20 cm	34-1064-87
3 mm	15 cm	34-1064-88
3 mm	20cm	34-1064-89
3 mm	25 cm	34-1064-90
4 mm	25 cm	34-1064-91



HARVESTER Cannula

18 круглых отверстий для забора жира
КАНЮЛЯ С РУЧКОЙ



ДИАМЕТР	ДЛИНА	Артикул
3 mm	15 cm	34-1065-29
3 mm	20cm	34-1065-30
3 mm	25 cm	34-1065-31
3 mm	30 cm	34-1065-32
4 mm	20 cm	34-1065-33
4 mm	25cm	34-1065-34
4 mm	30 cm	34-1065-35
4 mm	32 cm	34-1065-36

HARVESTER Cannula

18 круглых отверстий для забора жира
КАНЮЛЯ LUER LOCK



ДИАМЕТР	ДЛИНА	Артикул
2 mm	10 cm	34-1065-21
2 mm	12cm	34-1065-22
2 mm	15 cm	34-1065-23
2 mm	20 cm	34-1065-24
3 mm	15 cm	34-1065-25
3 mm	20cm	34-1065-26
3 mm	25 cm	34-1065-27
4 mm	25 cm	34-1065-28



BASKET Cannula

Три отверстия по кругу с выгнутыми краями
КАНЮЛЯ С РУЧКОЙ



ДИАМЕТР	ДЛИНА	Артикул
3 mm	15 cm	34-1066-04
3 mm	20cm	34-1066-05
3 mm	25 cm	34-1066-06
3 mm	30 cm	34-1066-07
4 mm	20 cm	34-1066-08
4 mm	25cm	34-1066-09
4 mm	30 cm	34-1066-10
4 mm	32 cm	34-1066-11
4 mm	35 cm	34-1066-12
5 mm	20 cm	34-1066-13
5 mm	25 cm	34-1066-14
5 mm	30 cm	34-1066-15
5 mm	35 cm	34-1066-16

BASKET Cannula

Три отверстия по кругу с выгнутыми краями
КАНЮЛЯ LUER LOCK



ДИАМЕТР	ДЛИНА	Артикул
2 mm	10 cm	34-1065-96
2 mm	12cm	34-1065-97
2 mm	15 cm	34-1065-98
2 mm	20 cm	34-1065-99
3 mm	15 cm	34-1066-00
3 mm	20cm	34-1066-01
3 mm	25 cm	34-1066-02
4 mm	25 cm	34-1066-03



КАНЮЛЯ С РУЧКОЙ



КАНЮЛЯ С РАЗЪЕМОМ

LUER LOCK



SPATULA Cannula

Кончик в виде шпателя
КАНЮЛЯ С РУЧКОЙ



ДИАМЕТР	ДЛИНА	АРТИКУЛ
3 mm	15 cm	34-1065-68
3 mm	20cm	34-1065-69
3 mm	25 cm	34-1065-70
3 mm	30 cm	34-1065-71
4 mm	20 cm	34-1065-72
4 mm	25cm	34-1065-73
4 mm	30 cm	34-1065-74
4 mm	32 cm	34-1065-75
4 mm	35 cm	34-1065-76
5 mm	20 cm	34-1065-77
5 mm	30 cm	34-1065-78

SPATULA Cannula

Кончик в виде шпателя
КАНЮЛЯ LUER LOCK



ДИАМЕТР	ДЛИНА	АРТИКУЛ
1,3 mm	5 cm	34-1065-57
1,3 mm	7 cm	34-1065-58
1,3 mm	9 cm	34-1065-59
1,5 mm	5 cm	34-1065-60
1,5 mm	7 cm	34-1065-61
1,5 mm	9cm	34-1065-62
1,5 mm	12 cm	34-1065-63
2 mm	19 cm	34-1065-64
2 mm	12cm	34-1065-65
2 mm	15 cm	34-1065-66
3 mm	15 cm	34-1065-67



LOOP Cannula

Кончик в виде петли
КАНЮЛЯ LUER LOCK



ДИАМЕТР	ДЛИНА	АРТИКУЛ
1,5 mm	9 cm	34-1066-60
2 mm	9 cm	34-1066-61
2 mm	12 cm	34-1066-62
2 mm	15 cm	34-1066-63
2 mm	20 cm	34-1066-64
3 mm	15 cm	34-1066-65
3 mm	20 cm	34-1066-66
3 mm	25 cm	34-1066-67



TOLEDO Cannula

Кончик в виде шпателя
КАНЮЛЯ С РУЧКОЙ



ДИАМЕТР	ДЛИНА	АРТИКУЛ
3 mm	15 cm	34-1065-90
3 mm	20cm	34-1065-91
3 mm	25 cm	34-1065-92
3 mm	30 cm	34-1065-93
4 mm	20 cm	34-1065-94
4 mm	25cm	34-1065-95

TOLEDO Cannula

Кончик в виде шпателя
КАНЮЛЯ LUER LOCK



ДИАМЕТР	ДЛИНА	АРТИКУЛ
1,3 mm	5 cm	34-1065-79
1,3 mm	7 cm	34-1065-80
1,3 mm	9 cm	34-1065-81
1,5 mm	5 cm	34-1065-82
1,5 mm	7 cm	34-1065-83
1,5 mm	9cm	34-1065-84
1,5 mm	12 cm	34-1065-85
2 mm	19 cm	34-1065-86
2 mm	12cm	34-1065-87
2 mm	15 cm	34-1065-88
3 mm	15 cm	34-1065-89



INJECTRION Cannula ИЗОГНУТАЯ

Одно дистальное отверстие
КАНЮЛЯ LUER LOCK



ДИАМЕТР	ДЛИНА	АРТИКУЛ
2 mm	15 cm	34-1066-54
2 mm	20cm	34-1066-55
2 mm	25 cm	34-1066-56
3 mm	20 cm	34-1066-57
3 mm	25 cm	34-1066-58
4 mm	25cm	34-1066-59

INJECTRION Cannula

Одно дистальное отверстие
КАНЮЛЯ LUER LOCK



ДИАМЕТР	ДЛИНА	АРТИКУЛ
1 mm	5 cm	34-1066-41
1 mm	7cm	34-1066-42
1,3 mm	7 cm	34-1066-43
1,3 mm	9 cm	34-1066-44
1,5 mm	9 cm	34-1066-45
1,5 mm	12cm	34-1066-46
2 mm	12 cm	34-1066-47
2 mm	15 cm	34-1066-48
2 mm	20 cm	34-1066-49
3 mm	15 cm	34-1066-50
3 mm	20 cm	34-1066-51
4 mm	20 cm	34-1066-52
4 mm	25 cm	34-1066-53



КАНЮЛЯ С РУЧКОЙ

LIPOSUCTION Cannula

Три отверстия по диагонали
КАНЮЛЯ С РУЧКОЙ



ДИАМЕТР	ДЛИНА	Артикул
3 mm	15 cm	34-0983-20
3 mm	20cm	34-0985-30
3 mm	25 cm	34-1087-30
3 mm	30 cm	34-1089-40
4 mm	20 cm	34-1062-20
4 mm	25cm	34-1062-25
4 mm	30 cm	34-1062-30
4 mm	32 cm	34-1063-30
4 mm	35 cm	34-1062-32
5 mm	30 cm	34-1063-32
5 mm	35 cm	34-0979-30



КАНЮЛЯ С РАЗЪЕМОМ

LUER LOCK

LIPOSUCTION Cannula

Три отверстия по диагонали
КАНЮЛЯ LUER LOCK



ДИАМЕТР	ДЛИНА	Артикул
1,5 mm	9 cm	34-0981-30
2 mm	9 cm	34-1066-68
2 mm	12 cm	34-1066-69
2 mm	15 cm	34-1062-15
2 mm	20 cm	34-1063-20
2 mm	25cm	34-1063-25
3 mm	15 cm	34-1063-15
3 mm	20 cm	34-1066-70
3 mm	25 cm	34-1066-71
4 mm	20 cm	34-1066-72
4 mm	25 cm	34-1066-73



COBRA Cannula

Одно сквозное и одно
боковое отверстие
КАНЮЛЯ С РУЧКОЙ



ДИАМЕТР	ДЛИНА	Артикул
3 mm	15 cm	34-1066-17
3 mm	20cm	34-1066-18
3 mm	25 cm	34-1066-19
3 mm	30 cm	34-1066-20
4 mm	20 cm	34-1066-21
4 mm	25cm	34-1066-22
4 mm	30 cm	34-1066-23
4 mm	32 cm	34-1066-24
4 mm	35 cm	34-1066-25
5 mm	20 cm	34-1066-26
5 mm	25 cm	34-1066-27
5 mm	30 cm	34-1066-28
5 mm	35 cm	34-1066-29

COBRA Cannula

Одно сквозное и одно
боковое отверстие
КАНЮЛЯ LUER LOCK



ДИАМЕТР	ДЛИНА	Артикул
2 mm	10 cm	34-1066-30
2 mm	12 cm	34-1066-31
2 mm	15 cm	34-1066-32
2 mm	20 cm	34-1066-33
3 mm	15 cm	34-1066-34
3 mm	20 cm	34-1066-35
3 mm	25 cm	34-1066-36
4 mm	20 cm	34-1066-37
4 mm	25 cm	34-1066-38
4 mm	30 cm	34-1066-39
5 mm	32 cm	34-1066-40



STANDARD Cannula

Четыре отверстия в ряд
КАНЮЛЯ С РУЧКОЙ



ДИАМЕТР	ДЛИНА	Артикул
3 mm	15 cm	34-1066-74
3 mm	20cm	34-1066-75
3 mm	25 cm	34-1066-76
3 mm	30 cm	34-1066-77
4 mm	20 cm	34-1066-78
4 mm	25cm	34-1066-79
4 mm	30 cm	34-1066-80
4 mm	32 cm	34-1066-81
4 mm	35 cm	34-1066-82
5 mm	20 cm	34-1066-83
5 mm	25 cm	34-1066-84
5 mm	30 cm	34-1066-85
5 mm	35 cm	34-1066-86

STANDARD Cannula

Четыре отверстия в ряд
КАНЮЛЯ LUER LOCK



ДИАМЕТР	ДЛИНА	Артикул
2 mm	10 cm	34-1066-87
2 mm	12 cm	34-1066-88
2 mm	15 cm	34-1066-89
2 mm	20 cm	34-1066-90
3 mm	15 cm	34-1066-91
3 mm	20 cm	34-1066-92
3 mm	25 cm	34-1066-93
4 mm	20 cm	34-1066-94
4 mm	25 cm	34-1066-95
4 mm	30 cm	34-1066-96
5 mm	32 cm	34-1066-97



STANDARD Cannula

24 круглых отверстия
КАНЮЛЯ LUER LOCK



ДИАМЕТР	ДЛИНА	Артикул
1,2 mm	12 cm	34-1066-98
2 mm	15 cm	34-1066-99
2 mm	20 cm	34-1067-00
2 mm	25 cm	34-1067-01
3 mm	25 cm	34-1067-92