

ELMED

INSTRUMENTS

GREEN LINE

Эльмед инструменты

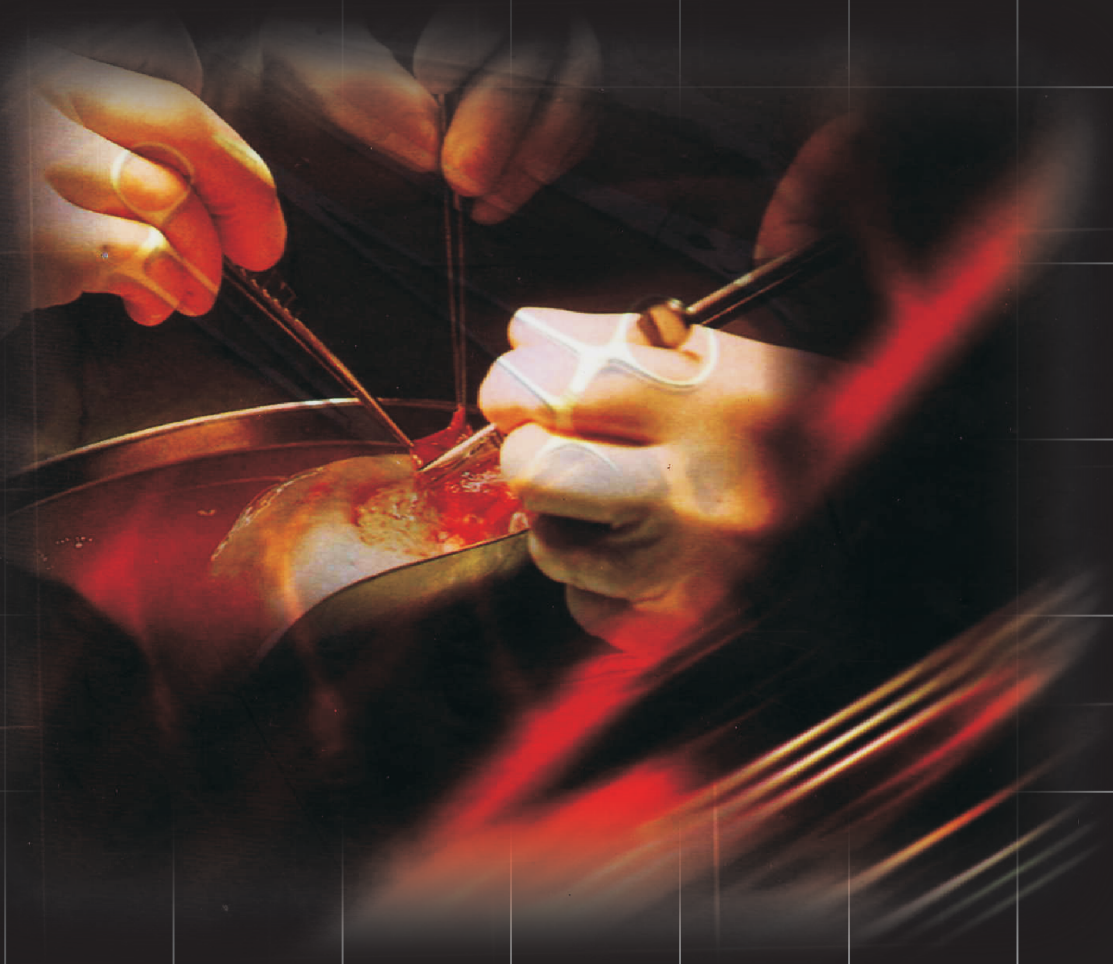

www.elmedinstruments.com



Frazier Suction Tube 17cm 6 Fig
Frazier Suction Tube 17cm 9 Fig
17cm/6 3/4"
2-0004-06
2-0004-09



Yankauer Suction Tube 27 Cm
2-0042-27



Scalpel Handle No. 3
4-0005-03



Scalpel Handle No. 4 With Scale
4-0013-04



Scalpel Handle No. 7
4-0017-07



Straight

Standard
Fig.1

7-0147-11 OPERATING SCISSOR STR (FIG. 1) 11.5CM/4 1/4" BL/BL

7-0147-13 13CM/5" BL/BL

7-0147-14 14.5CM/5 3/4" BL/BL

7-0147-15 15.5CM/6" BL/BL

7-0147-16 16CM/6 1/4" BL/BL

7-0147-18 18CM/7" BL/BL



Straight

Standard
Fig.2

OPERATING SCISSOR STR (FIG. 2)

7-0149-11 11.5CM/4 1/4" SH/BL

7-0149-13 13CM/5" SH/BL

7-0149-14 14.5CM/5 3/4" SH/BL

7-0149-15 15.5CM/6" SH/BL

7-0149-16 16CM/6 1/4" SH/BL

7-0149-18 18CM/7" SH/BL

Straight



Standard
Fig.3

- 7-0153-11 OPERATING SCISSOR STR (FIG. 3) 11.5CM/4 /14" SH/SH
- 7-0153-13
- 7-0153-14
- 7-0153-15
- 7-0153-16
- 7-0153-18



Standard
14cm/5 1/2"

- 7-0157-14 OPERATING SCISSOR STR FIG. 1 T/C 14CM/5 3/4" BL/BL
- 7-0159-14 OPERATING SCISSOR STR FIG. 2 T/C 14CM/5 3/4" SH/BL
- 7-0161-14 OPERATING SCISSOR STR FIG. 3 T/C 14CM/5 3/4" SH/SH



Fig. 1



Fig. 2



Fig. 3

Curved



Standard
Fig.1

- 7-0166-11 OPERATING SCISSOR CVD FIG. 1 11.5CM/4 1/4" BL/BL
- 7-0166-13 13CM/5 BL/BL
- 7-0166-14 14.5CM/5 3/4" BL/BL
- 7-0166-15 15.5CM/6" BL/BL
- 7-0166-16 16CM/6" BL/BL
- 7-0166-18 18CM/7" BL/BL

Curved



Standard
Fig. 2

- 7-0168-11 OPERATING SCISSOR CVD FIG. 2 11.5CM/4 1/2" SH/BL
- 7-0168-13 13CM SH/BL
- 7-0168-14 14.5CM/5 3/4" SH/BL
- 7-0168-15 15.5CM/6" SH/BL
- 7-0168-16 16CM/6 1/4" SH/BL
- 7-0168-18 18CM/7" SH/BL

Curved



Standard
Fig.3

- 7-0170-11 OPERATING SCISSOR CVD FIG. 3 11.5CM/4 1/2" SH/SH
- 7-0170-13 13CM/5" SH/SH
- 7-0170-14 14.5CM/5 3/4" SH/SH
- 7-0170-15 15.5CM/6" SH/SH
- 7-0170-16 16CM/6 1/4" SH/SH
- 7-0170-18 18CM/7" SH/SH



Standard
14 cm/5 1/2"

- 7-0174-14 OPERATING SCISSOR CVD FIG. 1 T/C 14.5CM/5 3/4" BL/BL
- 7-0176-14 T/C 14.5CM/5 3/4" SH/BL
- 7-0178-14 T/C 14.5CM/5 3/4" SH/SH



Fig. 1



Fig. 2



Fig. 3



LEXER SCISSOR STR
16CM/6 1/4"
7-0199-16



LEXER SCISSOR CVD
16CM/6 1/4"
7-0200-16



LEXER SCISSOR STR
16CM/6 1/4" T/C
7-0203-16



LEXER SCISSOR CVD
16CM/6 1/4" T/C
7-0204-16



RICHTER SCISSOR
14.5CM/5 3/4"
7-0228-14



MAYO SCISSOR STR
17CM/6 3/4"
7-0241-17



MAYO SCISSOR CVD
17CM/6 3/4"
7-0242-17

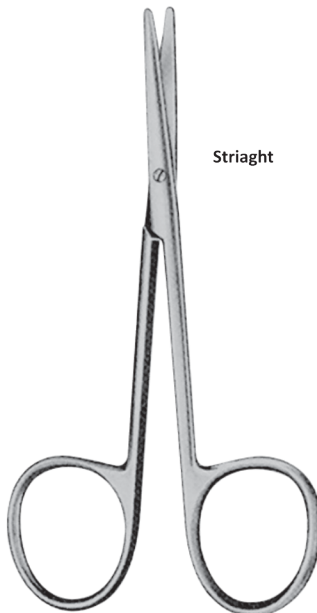

BABY-METZENBAUM SCISSOR STR
11.5CM/4 1/2"
7-0263-11

Striaight

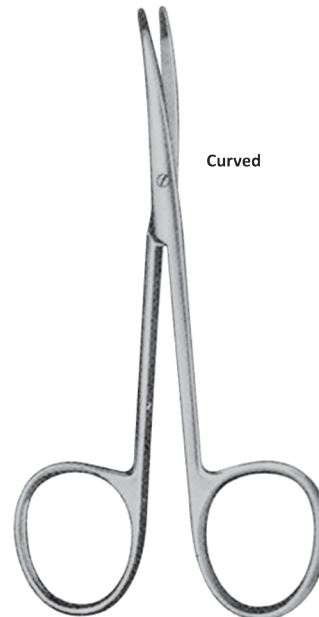

BABY-METZENBAUM SCISSOR CVD
11.5CM/4 1/2"
7-0264-11

Curved



METZENBAUM SCISSOR CVD SH/BL
14.5CM/5 3/4" FIG. 2
7-0294-14



METZENBAUM SCISSOR
STR BL/BL 14.5CM/5 3/4"
FIG. 1
7-0275-14



METZENBAUM SCISSOR STR
SH/BL 14.5CM/5 3/4"
FIG. 2
7-0277-14



METZENBAUM SCISSOR STR
SH/SH 14.5CM/5 3/4"
FIG. 3
7-0279-14

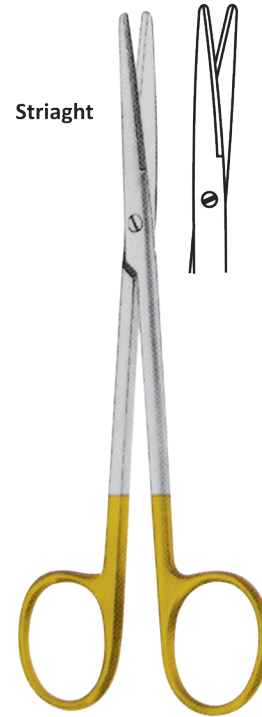

Striaight

METZENBAUM SCISSOR STR
BL/BL 14.5CM/5 3/4" T/C
7-0283-14

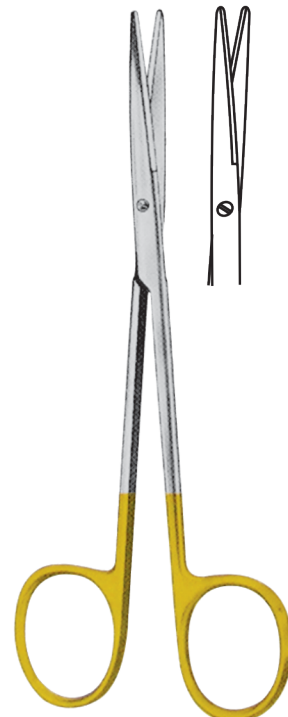

METZENBAUM-FINE SCISSOR STR
BL/BL 14.5CM/5 3/4" T/C
7-0285-14



Curved

METZENBAUM SCISSOR CVD
BL/BL 14.5CM/5 3/4" FIG. 1
7-0292-14

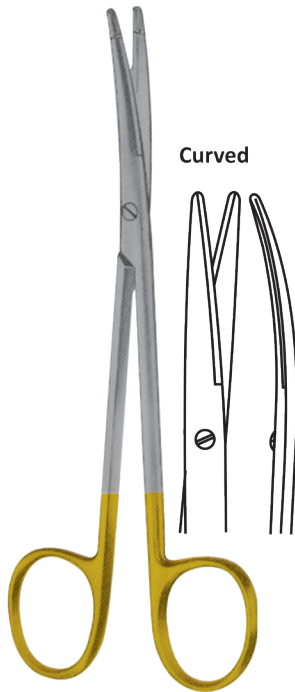

Curved

METZENBAUM SCISSOR CVD
BL/BL 14.5CM/5 3/4" T/C
7-0302-14



7-0313-18 METZENBAUM SCISSOR 5
TR BL/BL 18CM//7"
7-0313-20 BL/BL 20CM/8"
7-0313-23 BL/BL 23CM/9"
7-0313-25 STR BL/BL 25CM/10
7-0313-28 STR BL/BL 28CM
7-0313-30 STT BL/BL 30CM



Striaight

7-0311-18 METZENBAUM FINE SCISSOR
STR BL/BL 18CM//7"
7-0311-20 STR BL/BL 20CM/8"
7-0311-23 STR BL/BL 23CM/9"
7-0311-25 R STR BL/BL 25CM/10

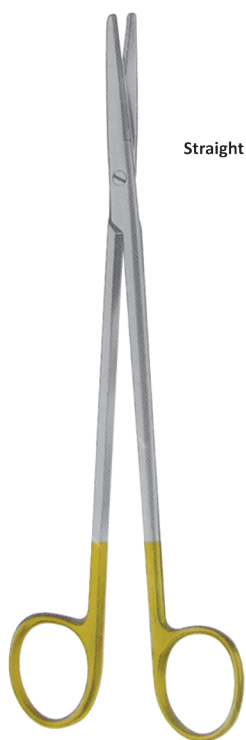

Straight



Straight



Curved

- 7-0322-18 METZENBAUM SCISSOR STR BL/BL T/C 18CM/7"
- 7-0322-20 STR BL/BL T/C 20CM//8"
- 7-0322-23 STR BL/BL T/C 23CM/9"
- 7-0322-25 STR BL/BL T/C 25CM/10"
- 7-0322-28 STR BL/BL T/C 28CM/11"
- 7-0322-30 STR BL/BL T/C 30CM/12"

- 7-0333-18 METZENBAUM SCISSOR CVD BL/BL 18CM/7"
- 7-0333-20 BL/BL 20CM/8"
- 7-0333-23 BL/BL 23CM/9"
- 7-0333-25 BL/BL 25CM/10"
- 7-0333-28 BL/BL 28CM/11"
- 7-0333-30 BL/BL 30CM/12"

- 7-0335-18 METZENBAUM SCISSOR CVD BL/BL 18CM/7"
- 7-0335-20 BL/BL 20CM/8"
- 7-0335-23 BL/BL 23CM/9"
- 7-0335-25 BL/BL 25CM/10"
- 7-0335-28 BL/BL 28CM/11"
- 7-0335-30 BL/BL 30CM/12"

- FINE SCISSOR STR 11.5CM/4 1/2"
- 7-0422-11

- FINE SCISSOR CVD 11.5CM/4 1/2"
- 7-0423-11



Straight



Curved



Straight



Curved



Extra Flat

- REYNOLDS SCISSOR STR 15CM
- 7-0431-15

- REYNOLDS SCISSOR CVD 15CM
- 7-0432-15

- 7-0469-09 FINE SCISSOR STR 9CM/3 1/2"
- 7-0469-10 FINE SCISSOR STR 10.5CM/4 1/4"
- 7-0469-11 FINE SCISSOR STR 11.5CM/4 1/2"

- 7-0470-09 FINE SCISSOR CVD 9CM/3 1/2"
- 7-0470-10 FINE SCISSOR CVD 10.5CM/4 1/4"
- 7-0470-11 FINE SCISSOR CVD 11.5CM/4 1/2"

- FINE SCISSOR STR EXTRA FLAT 10CM/4"
- 7-0475-10



Straight

**BABY-LEXER (KNAPP)
SCISSOR STR 10CM/4"
7-0491-10**



Curved

**BABY-LEXER (KNAPP)
SCISSOR CVD 10CM/4"
7-0492-10**



**KILNER (RAGNELL) SCISSOR 13CM/5"
KILNER (RAGNELL) SCISSOR 15CM/6"
7-0508-13
7-0508-15**



Tonsil Scissor

**PRINCE TONSIL SCISSOR 17-5CM/7"
7-0636-17**



Arteriotomy Scissor

**ADSON-FINE ARTERIOTOMY SCISSORS 17.5CM/7"
7-0640-17**



**TONNIS SCISSOR CVD 18CM/7"
7-0650-18**



**ADSON TONNIS SCISSOR 17.5CM/7"
7-0652-17**

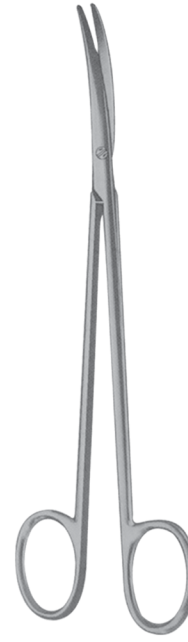

**ADSON TONNIS SCISSOR 17.5CM/7"
7-0652-17**

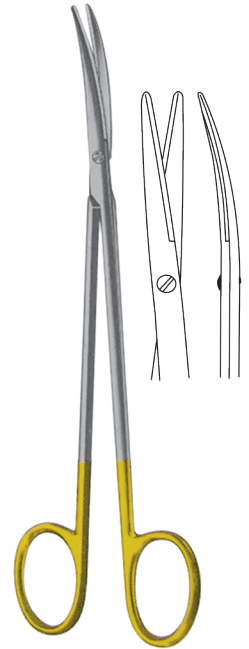

**ADSON TONNIS SCISSOR 17.5CM/7"
7-0656-17**

Straight



EYE SCISSOR STANDARD STR 10.5CM/4 1/4"
EYE SCISSOR STANDARD STR 11.5CM/4 1/2"
7-1055-10
7-1055-11

Curved



EYE SCISSOR STANDARD CVD 10.5CM/4 1/4"
EYE SCISSOR STANDARD CVD 11.5CM/4 1/2"
7-1056-10
7-1056-11



EYE SCISSOR STR 11.5CM/4 1/2"
7-1067-11



EYE SCISSOR CVD 11.5CM/4 1/2"
7-1068-11

Straight



7-1073-09 FINE EYE SCISSOR STR 9.5CM/3 1/2"
7-1073-10 FINE EYE SCISSOR STR 10.5CM/4 1/4"
7-1073-11 FINE EYE SCISSOR STR 11.5CM/4 1/2"

Curved

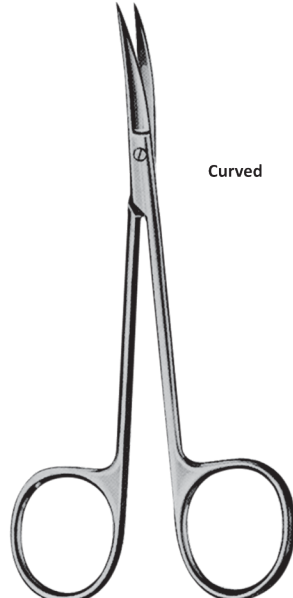

7-1074-09 FINE EYE SCISSOR CVD 9.5CM/3 1/2"
7-1074-10 FINE EYE SCISSOR CVD 10.5CM/4 1/4"
7-1074-11 FINE EYE SCISSOR CVD 11.5CM/4 1/2"

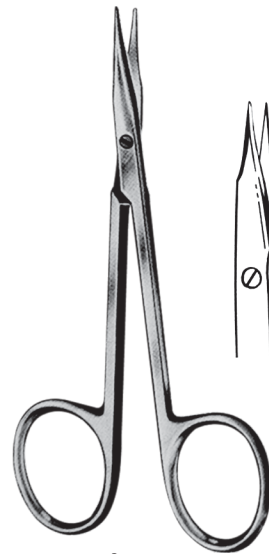

Stevens

7-1083-10 STEVEN TENOTOMY EYE
7-1083-11 SCISSOR POINTED STR 10.5CM/4 1/4"
11.5CM/4 1/2"



7-1084-10 STEVEN TENOTOMY EYE SCISSOR
7-1084-11 POINTED CVD 10.5CM/4 1/4"
ST CVD 11.5CM/4 1/2"



7-1220-13 LISTER BANDAGE SCISSOR 13CM/5"

7-1220-14 14CM/5 1/2"

7-1220-18 18CM/7"

7-1220-20 20CM/8"



LISTER BANDAGE SCISSOR 18CM/7" T/C

7-1222-18



8-0005-14 DRESSING FCP STR 14.5CM/5 3/4"

8-0005-18 DRESSING FCP STR 18CM/7"

8-0005-20 DRESSING FCP STR 20CM/8"

8-0005-25 DRESSING FCP STR 25CM/10"



ADSON-DRESSING
FCP 12CM/4 3/4"
8-0053-12



TAYLOR DRESSING FCP
17.5CM/7"
8-0089-17



8-0179-14 TISSUE FCP (1X2 TH)
14.5CM/5 1/2"

8-0179-18 (1X2 TH) 18CM/7"

8-0179-20 (1X2 TH) 20CM/8"

8-0179-25 (1X2 TH) 25CM/10"



8-0199-14 TISSUE FCP
(1X2 TH) 14CM/5 1/2"

8-0199-18 (1X2 TH) 18CM/7"

8-0199-20 (1X2 TH) 20CM/8"



ADSON TISSUE FCP
(1X2 TH) 12CM/4 3/4"

8-0249-12



TAYLOR TISSUE FCP
(1X2 TH) 17.5CM/6 3/4"

8-0291-17



LUCAE NASAL DRESSING
FCP 14CM/5 1/2"

8-0500-14



LUCAE NASAL DRESSING
FCP (1X2) 14CM/5 1/2"
8-0504-14



8-0494-12 TROELTSCH WILDE EAR DRESSING
FCP 12CM/4 3/4"
8-0494-15 FCP 15CM/6"



TROELTSCH EAR
DRESSING FCP 12CM/4 3/4"
8-0496-12



JANSEN (GRUENWALD) NASAL
DRESSING FCP 16CM/6 1/4"
8-0508-16



JANSEN NASAL DRESSING FCP
(1X2 TH) 16CM/6 1/4"
8-0512-16

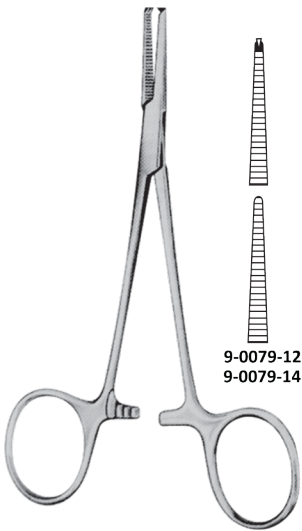

HALSTEAD MOSQUITO
A/FCP STR (SERR) 12CM/4 3/4"
A/FCP STR (SERR) 14CM/5 1/2"
A/FCP CVD (SERR) 12CM/4 3/4"
A/FCP CVD (SERR) 14CM/5 1/2"

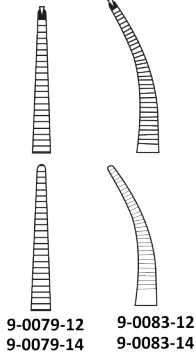

9-0079-12
9-0079-14
9-0083-12
9-0083-14

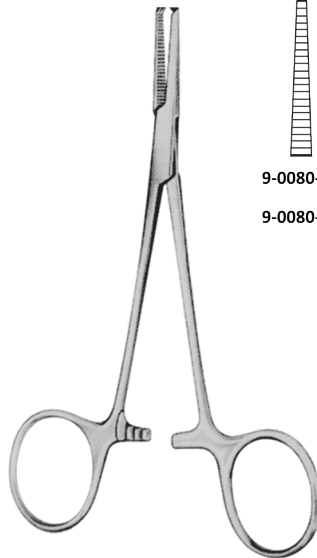

HALSTEAD MOSQUITO
A/FCP STR (1X2 TEETH) 12CM/4 3/4"
A/FCP STR (1X2 TEETH) 14CM/5 1/2"
A/FCP CVD (1X2 TEETH) 12CM/4 3/4"
A/FCP CVD (1X2 TEETH) 14CM/5 1/2"

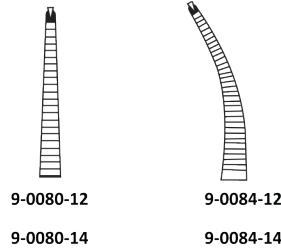

9-0080-12
9-0080-14
9-0084-12
9-0084-14



MICRO-MOSQUITO A/FCP STR SERR 12CM/4 3/4"
MICRO-MOSQUITO A/FCP CVD (SERR) 12CM/4 3/4"

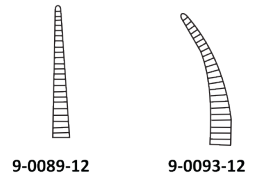

9-0089-12
9-0093-12

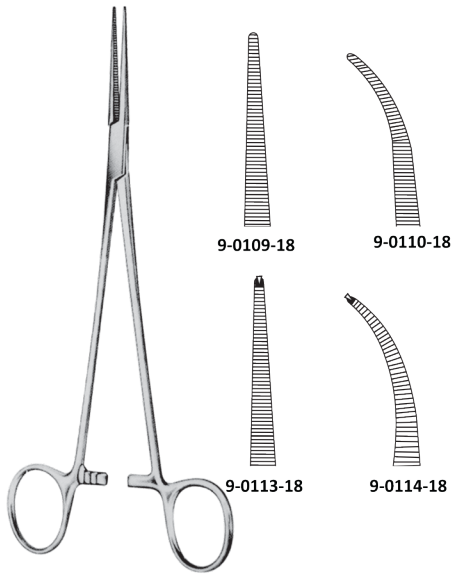

HALSTEAD MOSQUITO
A/FCP STR (SERR) 18CM/7"
A/FCP CVD (SERR) 18CM/7"
A/FCP STR (1X2 TH) 18CM/7"
A/FCP CVD (1X2 TH) 18CM/7"

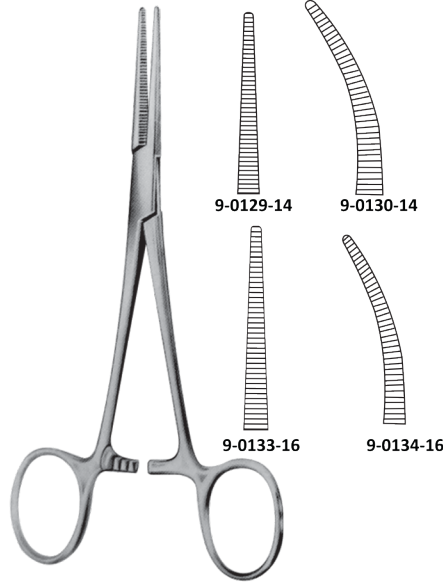

CRILE A/FCP STR 14CM/5 1/2"
CRILE A/FCP CVD 14CM/5 1/2"
CRILE-RANKIN A/FCP STR 16CM/6 1/4"
CRILE-RANKIN A/FCP CVD 16CM/6 1/4"



CRILE A/FCP STR (1X2 TH) 14CM/5 1/2"
CRILE A/FCP CVD (1X2 TH) 14CM/5 1/2"
CRILE-RANKIN A/FCP STR (1X2 TH) 16CM/6 1/4"
CRILE-RANKIN A/FCP CVD (1X2 TH) 16CM/6 1/4"

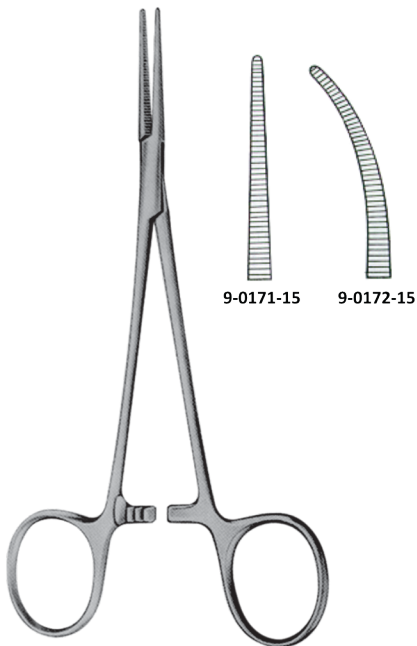

LERICHE A/FCP STR (SERR) 15CM/6"
LERICHE A/FCP CVD (SERR) 15CM/6"



R/PEAN A/FCP STR (SERR)
DELICATE 14CM/5 1/2"
CVD (SERR) DELICATE 14CM/5 1/2"
STR (SERR) DELICATE 16CM/6 1/4"
CVD (SERR) DELICATE 16CM/6 1/4"



KOCHER A/FCP DELICATE S
TR (1X2 TH) 14CM/5 1/2"
STR (1X2 TH) 16CM/6 1/4"
CVD (1X2 TH) 14CM/5 1/2"
CVD (1X2 TH) 16CM/6 1/4"

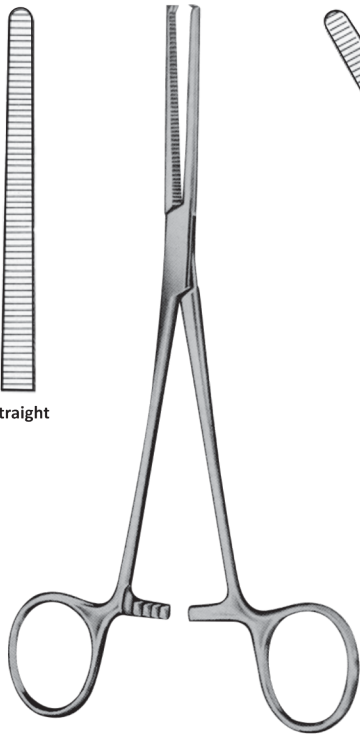
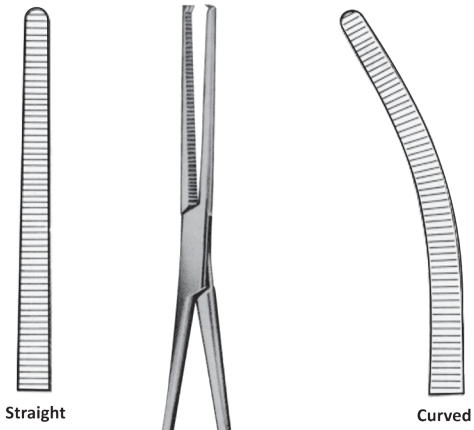

- 9-0195-14 OSCHNER-KOCHER
A/FCP STR (1X2 TH) 14CM/5 1/2"
- 9-0195-18 A/FCP STR (1X2 TH) 18CM/7"
- 9-0195-16 A/FCP STR (1X2 TH) 16CM/6 1/4"
- 9-0196-14 A/FCP CVD (1X2 TH) 14CM/5 1/2"
- 9-0196-16 A/FCP CVD (1X2 TH) 16CM/6 1/4"
- 9-0196-18 A/FCP CVD (1X2 TH) 18CM/7"

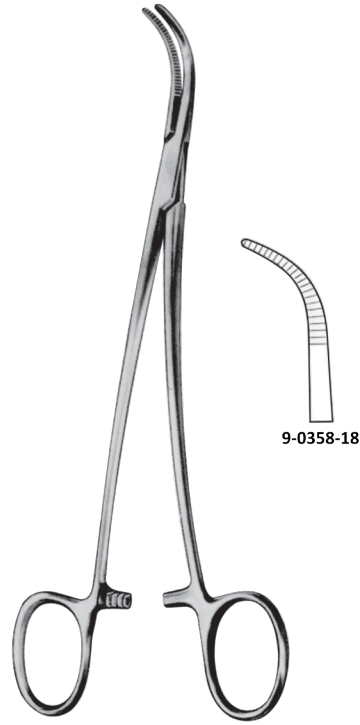

OVERHOLT-SLIM DISSECTING FCP 18CM/7"

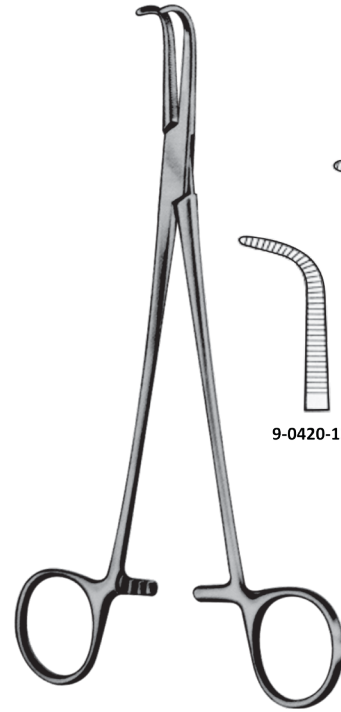
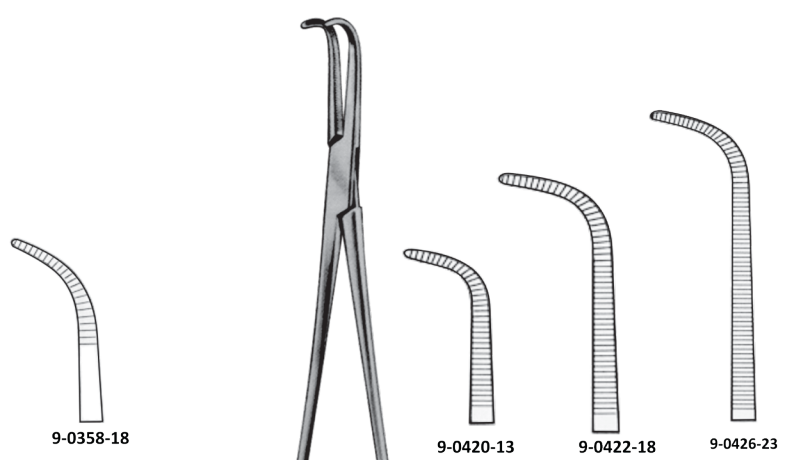

GEMINI DISSECTING FCP 13CM/5"
FCP 18CM/7"
FCP 23CM/9"

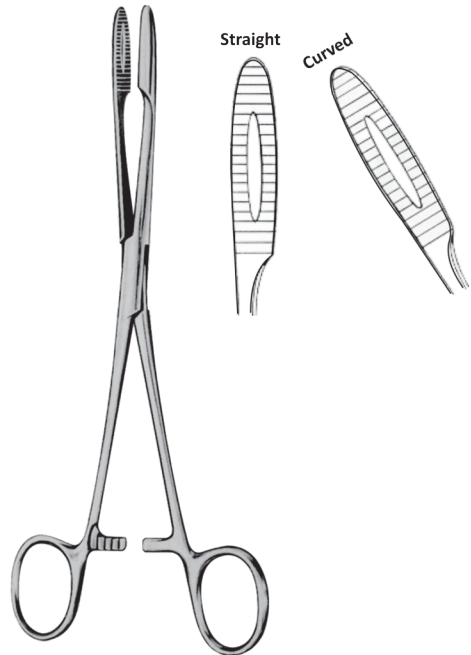

10-0025-25 GROSS-MAIER POLYPUS FCP
WITH RATCHET STR 25CM /10"
10-0026-25 FCP WITH RATCHET CVD 25CM /10"

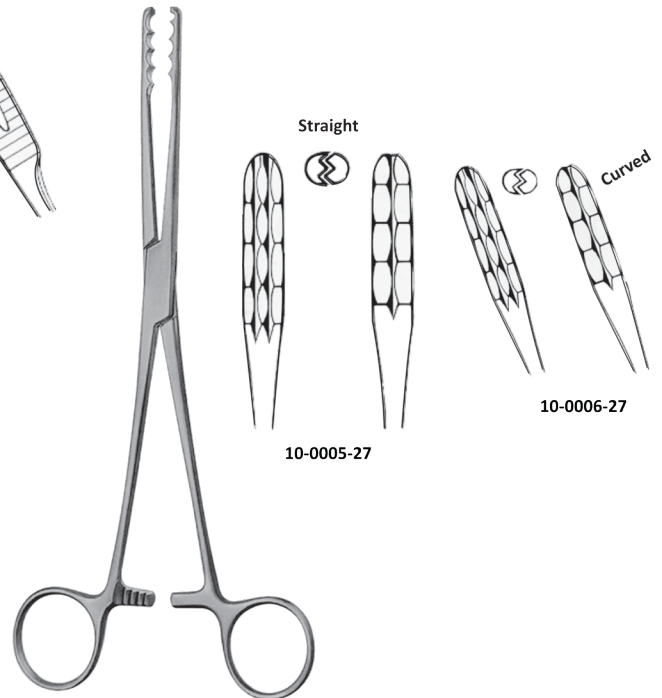

ULRICH COTTON SWAB
FCP STR 27CM/10 1/2"
FCP CVD 27CM/10 1/2"



9-0674-11 BACKHAUS TOWEL FCP 11CM/4 1/2"
9-0674-13 FCP 13CM/5"



PARKER-LANGENBECK RETRACTOR
(U.S. ARMY) 21CM/8 1/4" SET OF 2
11-0248-21



COLLIN-HARTMANN RETRACTOR 14CM / 5 1/2"
11-0228-01



Set

FARABAUF RETRACTOR
12CM / 4 3/4" SET OF 2
11-0262-12



Set

PARKER-MOLT RETRACTOR
16CM / 6 1/4" SET OF 2
11-0258-16

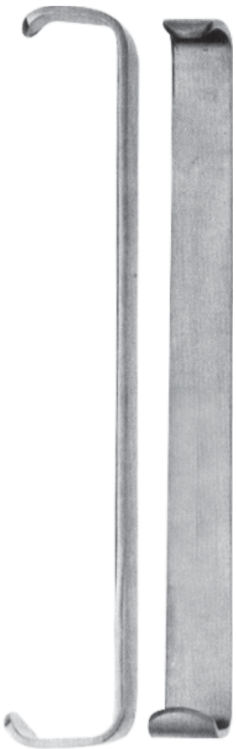

11-0266-02 FARABAUF RETRACTOR 7X9X120MM
11-0266-05 FARABAUF RETRACTOR 21X15X150MM



Sharp

VOLKMANN RETRACTOR SHARP
LARGE CVD 22CM / 8 3/4"
11-0279-22

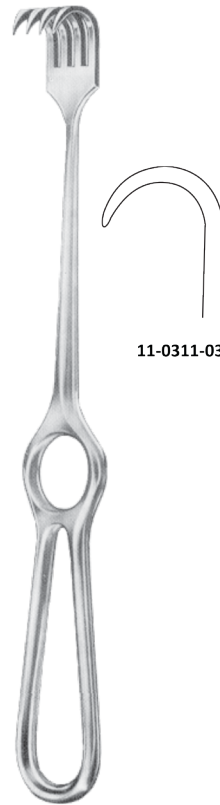

Semi Sharp

11-0311-03

KOCHER RETRACTOR SEMI SHARP 22CM/8 3/4" (3 PRONG)



11-0384-07 **KOCHER-LANGENBECK RETRACTOR**
21.5CM/8 1/2" (55X11MM)
11-0384-10 **RETRACTOR**
21.5CM/8 1/2" (80X16MM)

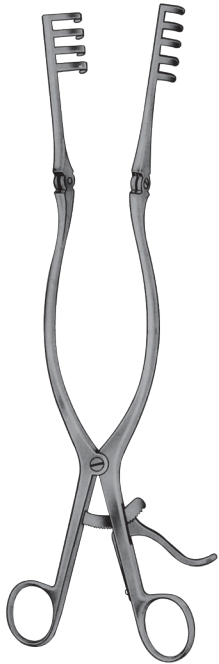

11-0843-02 BECKMANN-ADSON
RETRACTOR 31CM /12 1/4" (44MM) SHARP
11-0844-02 RETRACTOR 31CM /12 1/4" (44MM) BLUNT
11-0843-01 RETRACTOR 31CM /12 1/4" (25MM) SHARP
11-0844-01 RETRACTOR 31CM /12 1/4" (25MM) BLUNT



11-0785-13 WEITLANER RETRACTOR
13CM / 5" SHARP (3X4TH)
11-0785-16 16cm Sharp (3x4TH)
11-0786-13 13CM /5" BLUNT (3X4TH)
11-0786-16 16.5CM /6 1/2" BLUNT (3X4TH)

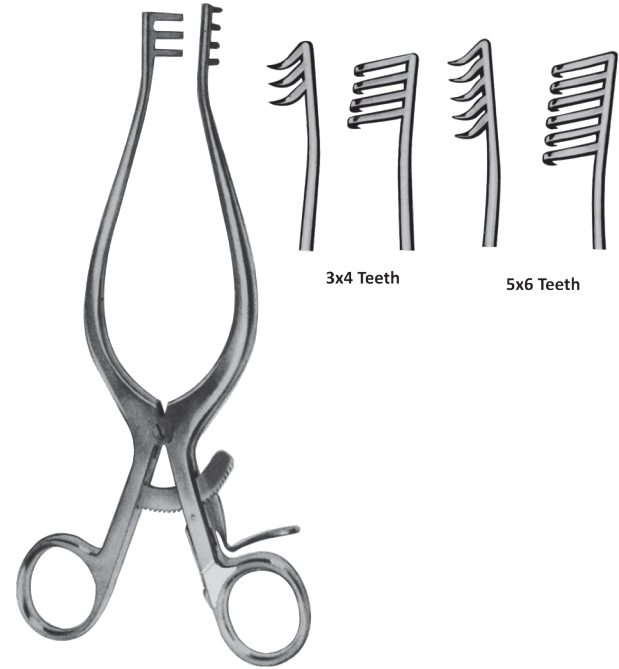

11-0819-20 WEITLANER RETRACTOR
20CM /8" SHARP (3X4 TH)
11-0819-25 25CM /10" SHARP(3X4TH)



11-0912-13 GELPI RETRACTOR 13CM/5"
11-0912-11 11CM/4 1/2"
11-0912-18 18CM/7 1/2"

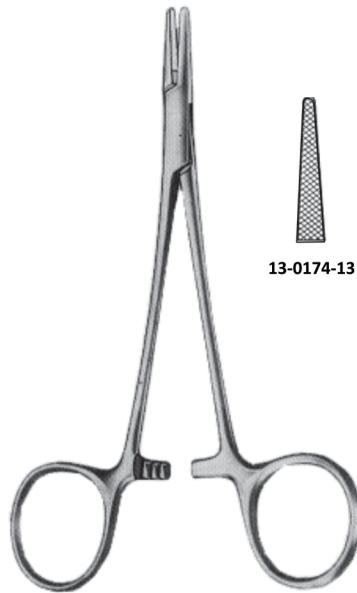

13-0174-13
HALSEY NEEDLE HOLDER 13CM/5" SERR



HEGAR-BAUMGARTNER NEEDLE HOLDER
14CM/5 1/2"
13-0196-14



13-0206-14 MAYO-HEGAR NEEDLE HOLDER 14CM/5 1/2"

- 13-0206-16 16CM/6 1/4"
- 13-0206-18 18CM/7"
- 13-0206-20 20CM/8"
- 13-0206-24 24CM/9 1/2"
- 13-0206-26 26CM/10 1/4"
- 13-0206-30 30CM/12"



13-0214-16 HEGAR NEEDLE HOLDER HEAVY PATTERN 16CM/6 1/4"
13-0214-18 18CM/7"



CRILE-WOOD NEEDLE HOLDER 15CM/6"
13-0238-15

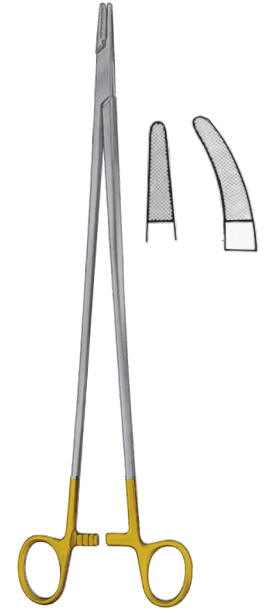

- 13-0312-16 Mayo-Hegar Needle Holder T/C 16cm
- 13-0312-18 T/C 18CM/7"
- 13-0312-20 T/C 20CM/8"
- 13-0312-24 T/C 24CM/9 1/2"
- 13-0312-26 T/C 26CM/10 1/2"

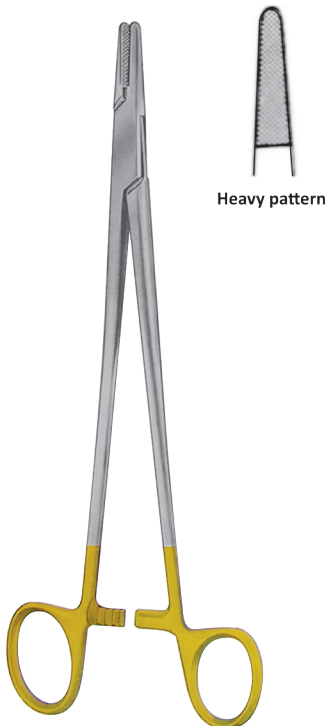

MAYO-HEGAR NEEDLE HOLDER T/C 20CM/8" HEAVY PATTERN
13-0320-20

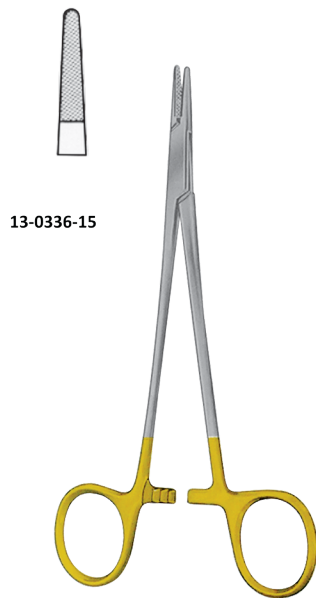

13-0336-15
CRILE-WOOD NEEDLE HOLDER T/C 15CM/6"

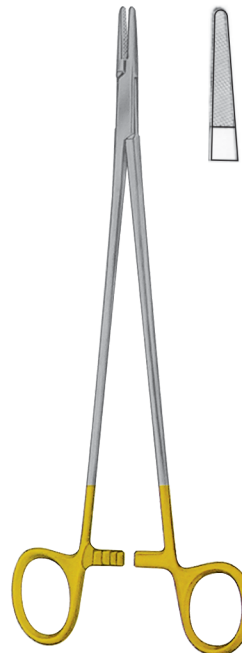

- 13-0342-18 CRILE-WOOD NEEDLE HOLDER T/C 18CM/7"
- 13-0342-20 T/C 20CM/8"
- 13-0342-23 T/C 23CM/9"

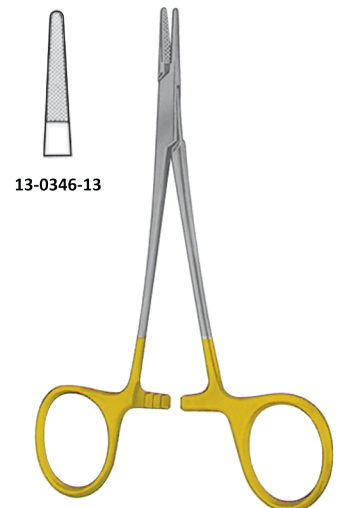

13-0346-13
HALSEY NEEDLE HOLDER T/C 13CM/5" SERR

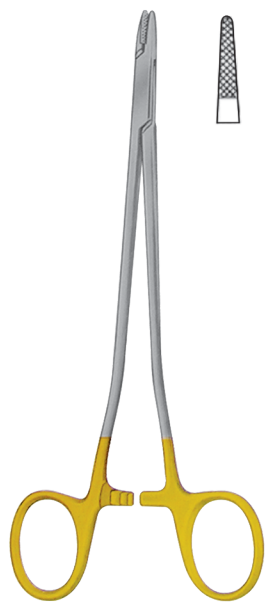

13-0370-15 SWEDISH PATTERN
NEEDLE HOLDER T/C 15CM/6"

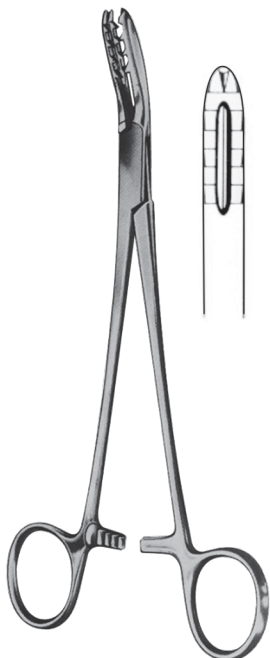

BIRCHER-GANSKE BONE
HOLDING FCP STR 20CM / 8"
15-0710-20

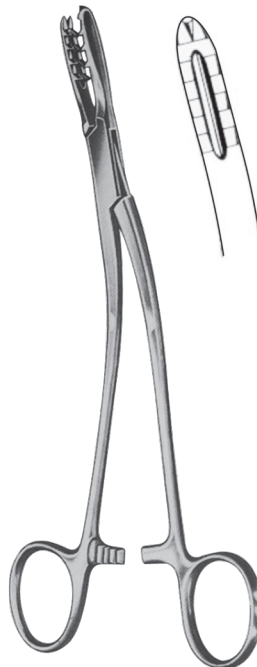

BIRCHER-GANSKE BONE
HOLDING FCP CVD 20CM / 8"
15-0712-20

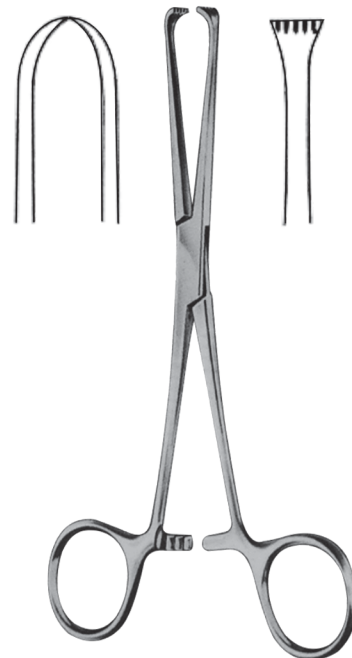

ALLIS INTESTINAL FCP BABY 15CM / 6"
(Аллис кишечный ФКП бэби)
19-0020-15



WIRE CUTTING PLIER
(Кусачки)
T/C 22CM / 8 3/4" D/A
FRONT CT
15-1224-22



MATHIEU RECTAL SPECULUM 19.5CM / 7 3/4"
19-0212-19



SIM'S RECTAL SPECULUM
15CM / 6" SOLID
19-0204-15



PRATT RECTAL SPECULUM 20.5CM / 8"
19-0200-20



19-0224-01 HIRSCHMANN ANASCOPE
16MM X 65MM FIG. 1
19-0224-02 19MM X 65MM FIG. 2
19-0224-03 22MM X 65MM FIG. 3
19-0224-04 25MM X 65MM FIG. 4



19-0236-01 KELLY PROCTOSCOPE 22MM X 50MM
19-0236-02 22MM X 100MM
19-0236-03 22MM X 140MM
19-0236-04 22MM X 200MM



19-0240-01 KELLY SPHINCTEROSCOPE
21MM X 50MM
19-0240-02 27MM X 50MM



21-0004-01 Cusco Vaginal Speculum
75mm x 32mm Side Screw
21-0004-02 85MM X 35MM SIDE SCREW
21-0004-03 100MM X 37MM SIDE SCREW



21-0008-01 CUSCO VAGINAL SPECULUM
75MM X 32MM SIDE SCREW
21-0008-02 85MM X 35MM CENTRE SCREW
21-0008-03 100MM X 37MM CENTRE SCREW



- | | |
|------------|--|
| 21-0224-40 | HEGAR DILATOR 3 / 4MM - 17 / 18MM SET OF 8 |
| 21-0226-60 | 1 / 2MM - 25 / 26MM SET OF 13 |
| 21-0224-02 | 1 / 2MM D/E |
| 21-0224-04 | 3 / 4MM D/E |
| 21-0224-06 | 5 / 6MM D/E |
| 21-0224-08 | 7 / 8MM D/E |
| 21-0224-10 | 9 / 10MM D/E |
| 21-0224-12 | 11 / 12MM D/E |
| 21-0224-14 | 13 / 14MM D/E |
| 21-0224-16 | 15 / 16MM D/E |
| 21-0224-18 | 17 / 18MM D/E |
| 21-0224-20 | 19 / 20MM D/E |
| 21-0224-22 | 21 / 22MM D/E |
| 21-0224-24 | 23 / 24MM D/E |
| 21-0224-26 | 25 / 26MM D/E |



- | | |
|------------|-------------------------|
| 21-0608-01 | 25CM FIG. 1 SERR HANDLE |
| 21-0608-02 | 25CM FIG. 2 SERR HANDLE |
| 21-0608-03 | 25CM FIG. 3 SERR HANDLE |
| 21-0608-04 | 25CM FIG. 4 SERR HANDLE |
| 21-0608-05 | 25CM FIG. 5 SERR HANDLE |
| 21-0608-06 | 25CM FIG. 6 SERR HANDLE |
| 21-0609-01 | 25CM FIG. 1 SERR HANDLE |
| 21-0609-02 | 25CM FIG. 2 SERR HANDLE |
| 21-0609-03 | 25CM FIG. 3 SERR HANDLE |
| 21-0609-04 | 25CM FIG. 4 SERR HANDLE |
| 21-0609-05 | 25CM FIG. 5 SERR HANDLE |
| 21-0609-06 | 25CM FIG. 6 SERR HANDLE |



25-0510-01



25-0510-02



25-0510-03



25-0510-04



25-0512-02

25-0512-03

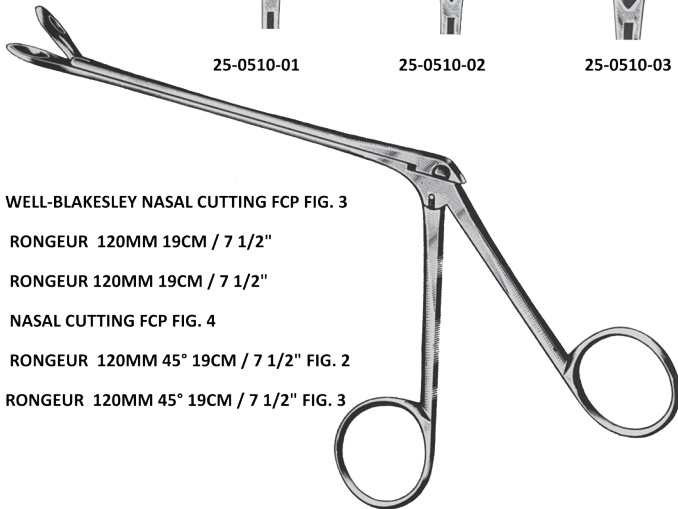

- WELL-BLAKESLEY NASAL CUTTING FCP FIG. 3
RONGEUR 120MM 19CM / 7 1/2"
- RONGEUR 120MM 19CM / 7 1/2"
- NASAL CUTTING FCP FIG. 4
RONGEUR 120MM 45° 19CM / 7 1/2" FIG. 2
- RONGEUR 120MM 45° 19CM / 7 1/2" FIG. 3



KRAUSE NASAL SNARE
26CM / 10 1/4"
28-0056-26



**KRAUSE-VOSE NASAL
SNARE 26CM / 10 1/4"**
28-0060-26



**LANGE-WILDE NASAL
SNARE 24CM / 9 1/4"**
28-0064-24



**LITTAUER EAR FCP
12CM / 4 3/4"**
27-0140-12



**HARTMANN FINE EAR
FCP 12CM / 4 3/4"**
27-0144-12



**Hartmann Fine
Ear Fcp 14cm**
27-0148-14



**KILLIAN NASAL SPECULA 35MM
50MM
75MM**



**FIG. 1
28-0042-01**



**FIG. 2
28-0042-02**



**FIG. 3
28-0042-03**

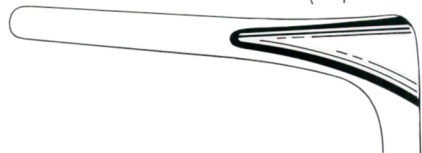

PACKAGE OF 1 DOZEN EACH 0.3MM
28-0068-10



HARTMANN NASAL FCP 20CM / 8"
28-0084-20

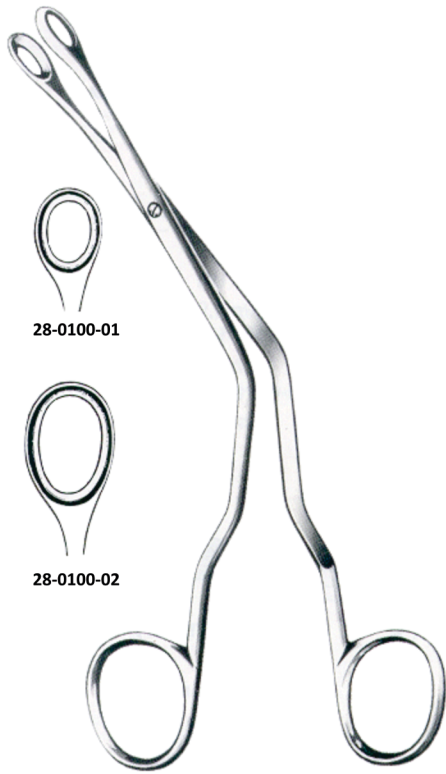

28-0100-01

28-0100-02

Luc Nasal Septum Fcp 20cm Fig. 1
Fcp 20cm Fig. 2



28-0108-01



28-0108-02



28-0108-03



28-0108-04



BRUENING NASAL SEPTUM FCP 19CM / 7 1/2" FIG. 1
FCP 19CM / 7 1/2" FIG. 2
FCP 19CM / 7 1/2" FIG. 3
FCP 19CM / 7 1/2" FIG. 4



MYLES NASAL CUTTING FCP FIG. 2
28-0134-02



GRUNWALD NASAL CUTTING FCP FIG. 2
28-0138-02



MYLES NASAL CUTTING FCP FIG. 2
28-0134-02

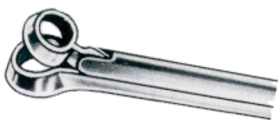

○ 28-0144-01 HARTMANN NASAL CUTTING FCP 5MM
○ 28-0144-02 FCP 7MM
○ 28-0144-03 FCP 9MM

28-0216-03 BALLENGER SEPTUM KNIFE 3MM 20CM / 8"
28-0216-04 4MM 20CM / 8"
28-0216-05 5MM 20CM / 8"
28-0217-03 CVD 3MM 20CM / 8"
28-0217-04 CVD 4MM 20CM / 8"
28-0217-05 CVD 5MM 20CM / 8"





28-0552-01

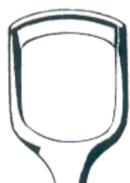

28-0552-02



28-0552-03

BECKMANN ADONOID CURETTE 22CM / 8 3/4" FIG. 1
22CM / 8 3/4" FIG. 2
22CM / 8 3/4" FIG. 3



DENHART MOUTH GAG 12CM / 4 3/4"
29-0044-12



29-0037-11 Molt Mouth Gag 11cm
29-0037-14 GAG 14CM / 5 1/2"

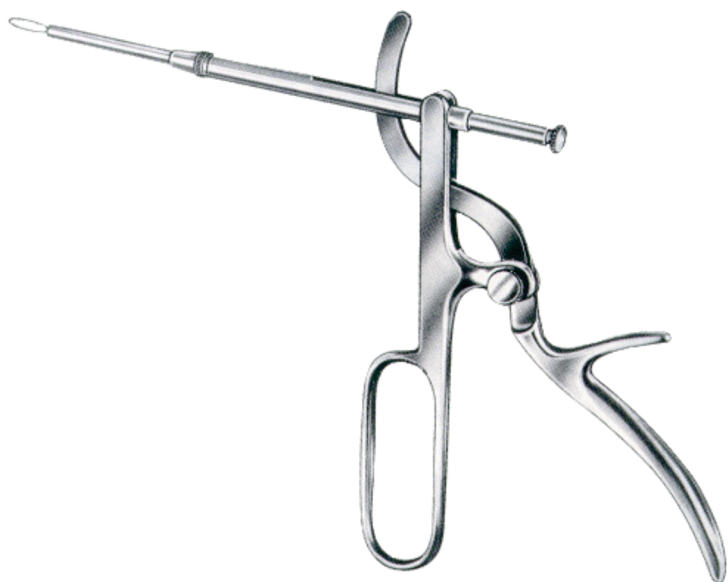

TYDING TONSIL SNARE WITH 1 STR TIP
30-0134-00



HARTMANN TONSIL PUNCH FCP 17MM
30-0142-17

P.O.BOX # : 1656, RORAS ROAD, NOWL, SIALKOT - PAKISTAN
Tel: +92-52-3552944, 3550244, 3557728-9
Fax: +92-52-3557730, 3558830
E-mail: info@elmedinstruments.com
Web: www.elmedinst.com

cGMP
CERTIFIED

